

GALAXY V

(030166)

Scanned 2004-02-20 by OH2FH

MANUAL # 183-40

PRICE \$2.00

PAGE 1

INSTRUCTION MANUAL

GALAXY V

SECTION I

UNPACKING AND DAMAGE CLAIMS

1-1.....DAMAGE - APPARENT & HIDDEN

1-2.....UNPACKING

SECTION II

2-1.....LOCATIONS OF CONTROLS AND ADJUSTMENTS

2-2.....CONNECTIONS OF POWER, KEY, MICROPHONE, ETC.

2-3.....SET-UP ADJUSTMENTS

2-4.....ANTENNA CONSIDERATIONS

SECTION III

OPERATION

3-1.....FIXED STATION FOR 115 VAC OPERATION

3-2.....MOBILE STATION FOR 12 VDC OPERATION

3-3.....CONNECTIONS AND USE OF ACCESSORY ITEMS

SECTION IV

THEORY OF OPERATION

4-1.....GENERAL CIRCUIT ANALYSIS

4-2.....PERFORMANCE SPECIFICATIONS

SECTION V

SERVICING IN THE FIELD

5-1.....VOLTAGE AND RESISTANCE CHART

5-2.....ALIGNMENT

SECTION VI

SERVICE AND RETURNS

6-1..... ORDERING PARTS AND SERVICE INFORMATION

6-2..... RETURNING PARTS AND EQUIPMENT FOR SERVICE AND REPLACEMENT

SECTION VII

PARTS LISTS AND SCHEMATICS

7-1..... SCHEMATICS

7-2..... PARTS LISTS

SECTION VIII

WARRANTY INFORMATION

8-1..... SPECIFICATIONS AND HANDLING OF WARRANTY PROBLEMS

SECTION I

1-1 It is assumed the purchaser has the unit removed from the carton by the time this manual has been read. **NOTE!** Some tubes and parts may be packed internally and other precautions will be necessary before attempting to apply power. Take notice of any notes or tags relating to parts packaging.

1-2 **DAMAGE:** This equipment has been carefully packed for safe arrival **IF PROPERLY HANDLED EN ROUTE.**

(a) OBVIOUS DAMAGE

If the carton showed signs of rough handling, you should have made such notation on the delivering carrier's receipt. If inspection shows obvious damage such as loose parts, broken parts, etc., the delivering carrier must be contacted immediately and a joint inspection made with this carrier's agent. The joint inspection is **NOT** a claim but an acknowledgement that the equipment was damaged. The form does **not** assign responsibility for the damage, but prepares the foundation on which to file a claim. The carrier will then acknowledge or decline the claim at their main office and a local agent may not decline to enter a claim. If the shipment was parcel post, contact your local postmaster for the necessary forms and he will help you enter the claim.

(b) HIDDEN DAMAGE

In many cases the carton may not be damaged but the equipment may suffer internal damage not obvious on delivery of the shipment. The procedure for filing the claim would be the same as above.

Remember, the responsibility for safe delivery rests with the carrier. The responsibility in obtaining reimbursement for damage rests with **YOU**. Prompt action on your part will speed adjustments. Our warranty in no way covers malfunction or damage which is a result of improper handling by a carrier. Under no circumstances should you return merchandise to your dealer before instigating the necessary forms. To do so can jeopardize your investment and the costs of necessary repairs may be a burden you will have to assume. After joint inspection forms have been completed, contact your dealer for assistance.

SECTION II

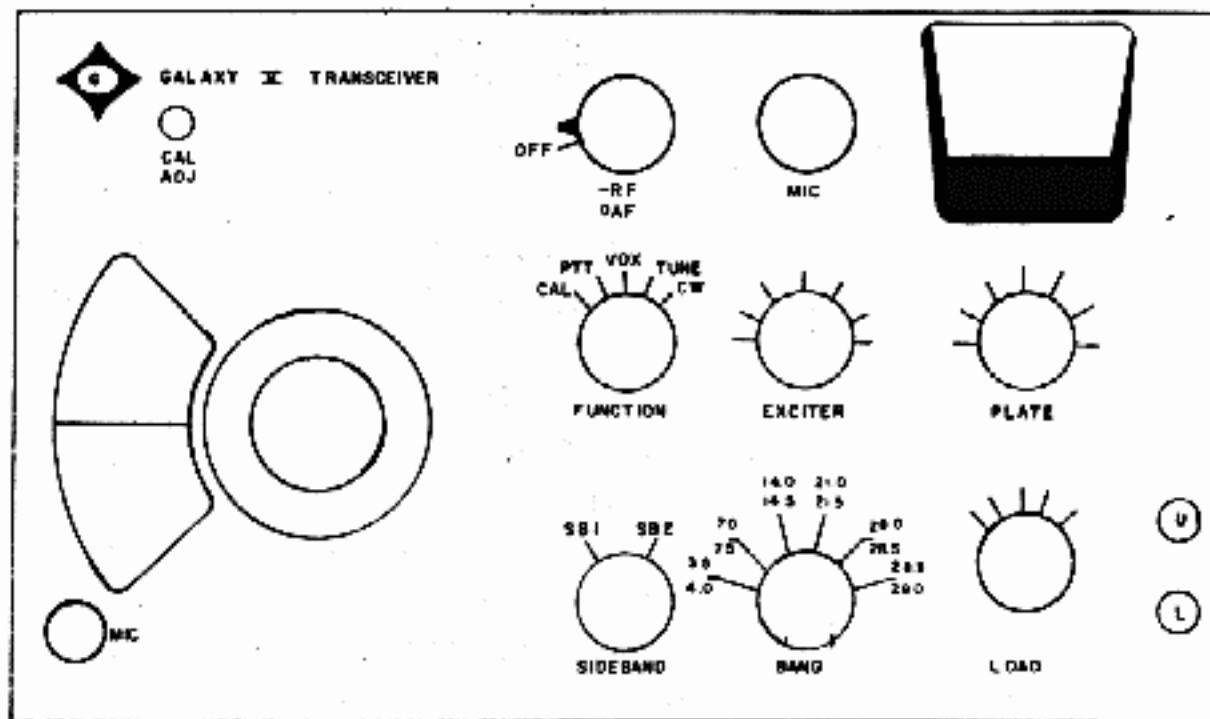

2-1 LOCATION OF CONTROLS, FRONT PANEL

- CAL** Small knurled knob in upper left-hand of panel. Used to set actual frequency and dial indication in agreement.
- O AF** At top of panel. Knob part of concentric control for audio volume on receiving.
- RF** Under above knob. Small lever control sets receiver RF gain. Used to reduce overload on extremely strong signals. Maximum RF gain occurs with the control maximum clockwise.
- FUNCTION** A five-position rotary switch.
Function controls:
- CAL** Turns on internal 100 Kc. Calibrator if this accessory is installed.
- PTT** Allows push-to-talk operation with a suitable microphone. Will not permit VOX to operate.
- VOX** Will enable VOX to be used if this accessory item is installed and properly adjusted. PTT can also be used in this position.
- TUNE** Turns transmitter on at reduced power for proper tune-up. NOTE! SB switch must be on SB2 position.
- CW** Sets transmitter on CW mode. To be used only after unit tuned on TUNE position. NOTE! MIC. control must be max. clockwise for CW operation. You must use SB2 sideband position.

SECTION II

2-1 LOCATION OF CONTROLS, FRONT PANEL, Continued

- EXCITER** Tunes receiver input and final grid to resonance.
- PLATE** Resonates final transmitter plate circuit.
- LOAD** Matches final output to load presented by the antenna, within normal matching range of 40-100 Ohms resistive.
- SIDEBAND** This switch serves two operations. In normal operation it selects the desired sideband, either upper or lower. The sideband in use is indicated by the panel lamps on the right side, marked "U" or "L". When the function switch is in either TUNE or CW position, the sideband switch **MUST** be in the SB2 position. Notice color matches these positions.
- MIC.** This control serves two operations. In normal usage, it adjusts the transmitting microphone gain. In TUNE or CW, it sets the drive level to the final.
- BANDSWITCH** Selects the desired band (500 Kc. ranges). Note the colors correspond to colors on the tuning dial. The lowest frequency number on the bandswitch is added to the dial reading to obtain actual frequency. (ie: Bandswitch on 3.5-4.0 position. Dial reads 440. Actual frequency is 3.5Mc. (3,500 Kc.) and added to dial, this totals 3,940 Kc.)
- MIC.** A microphone jack in the lower left corner of the panel. Accepts a small 3/16" three-circuit plug, such as Switchcraft S-260, or equal (PL68 type).

SECTION II

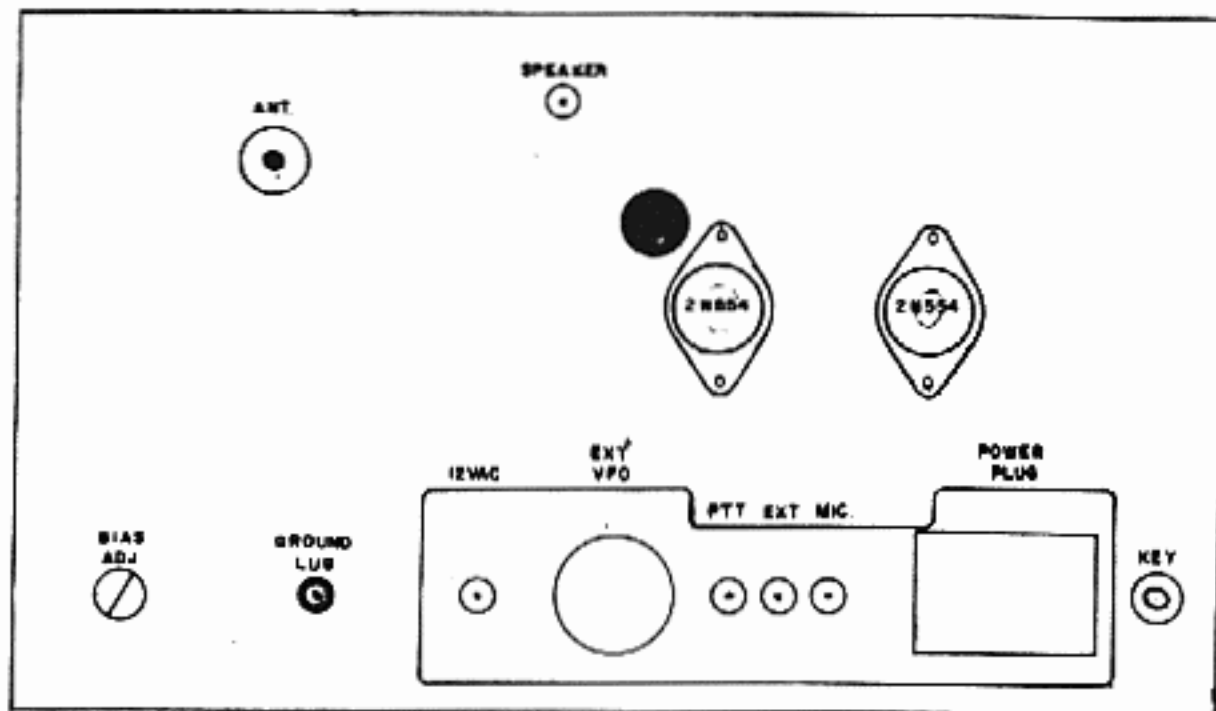

2-1 LOCATION OF CONTROLS, REAR PANEL

- ANT.** Coax jack accepting PL259 plug. 52 Ohm nominal.
- SPEAKER** Audio output jack J10. Attach 3/8 Ohm PM type speaker or earphones.
- HOLE** Hole, near transistor, for passing coax cable from remote VFO to internal VFO.
- BIAS ADJ.** Potentiometer R33 to set bias on final amplifier tubes.
- 12 VAC** Jack J12. To obtain voltage for meter illumination on DELUXE ACCESSORY CONSOLE.
- EXT. VFO** Socket J1. Supplied with jumper plug which is removed when the accessory REMOTE VFO is connected.
- PTT** Used to connect remote PTT switch for foot operation, etc., J6.
- EXT.** Used to control other devices which require a grounded circuit (J5) in transmit condition. Do not apply over 70 volts AC/DC, or over 1 Amp. through these contacts.
- MIC.** Accessory input for microphone. Normally used for phone patch in DELUXE ACCESSORY CONSOLE, J4
- POWER PLUG** Main power connector for AC or DC power supply. P1
- KEY** Keying jack J3. Use standard two-circuit plug. Switchcraft 240, etc.

SECTION II

2-1 LOCATION OF CONTROLS, REAR PANEL, Continued

GROUND LUG A bolt to attach an external ground wire.

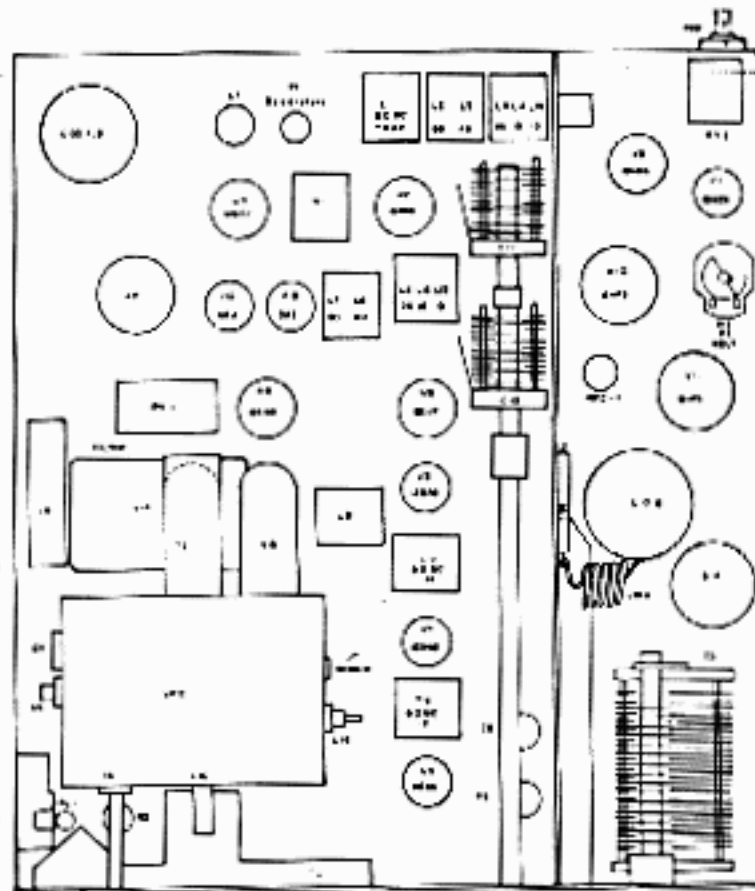

CHASSIS TOP VIEW

The only internal adjustments usually made are: The "S" meter, R2, located on the chassis beside the VFO dial light. The VOX, in socket J9, where the controls are on the printed circuit board and the 100 Kc. calibrator which plugs into the octal socket J2.

The VOX socket is supplied with a jumper plug which must be inserted to operate the transmitter.

Other internal controls and adjustments should not be moved unless there is a malfunction and, then, only when the operator is thoroughly familiar with the procedures.

2-2 CONNECTIONS FOR POWER, MICROPHONE, ETC.

PL68
MICROPHONE---There are two microphone input jacks. The panel jack, J8, is normally used and requires a three-circuit 3/16" plug, such as Switchcraft S 260, or equal. This is similar to the popular PL68 type. Connect ground (shield) to the barrel (sleeve) of the plug. Connect audio to the ring (the isolated part back from the tip) and connect the push-to-talk wire to the tip. Most microphones have just three wires but, if yours has four, you should connect the extra push-to-talk wire to the shield around the audio wire.

SECTION II

2-2 CONNECTIONS FOR POWER, MICROPHONE, ETC., Continued

NOTE: Some microphones have the element shorted when the push-to-talk is off. In this case, the contacts must be disabled to operate VOX.

The other microphone input is on the rear panel and is a phono type jack. It may be used for any special application of the user, except it will be used for phone patch when the DELUXE ACCESSORY CONSOLE is attached.

SPEAKER---The phono jack at the top of the rear panel. Connect any PM type speaker, 4 to 8 Ohms, or any magnetic earphones. Normally, the DELUXE SPEAKER CONSOLE or the speaker in the DELUXE ACCESSORY CONSOLE will be used.

GROUND---A bolt post on the rear panel. Connect a heavy (#8 preferred) wire to a direct ground source. DO NOT USE WATER OR GAS PIPES. This wire should be as short as possible and, if over 5 feet, two ground wires should be used, one of which is exactly twice as long as the first. This will tend to eliminate a ground wire resonance. A ground rod should be at least 6 feet long and driven into the ground near the equipment.

POWER---Connect the power cable supplied with our AC supply to the 12 pin socket P1.

TURN OFF THE AC SWITCH
(switch on receiving audio control)
INSERT AC PRIMARY POWER CORD

2-3 SET-UP ADJUSTMENTS

Place FUNCTION switch in PTT position. Turn on AC supply with the switch located on the AF gain control. Allow initial warm-up of 10 minutes. Now, adjust "S" meter with internal control R2 for zero reading.

Now, connect antenna. Set SB selector switch to SB1. Set MIC. GAIN to minimum. (Fully - counter-clockwise) Place FUNCTION to CW position and set R33 bias pot to obtain meter reading of S4-1/2 (exactly between S4 and S5). Set FUNCTION switch to PTT.

2-4 ANTENNA CONSIDERATIONS

The antenna is connected, and we know you are anxious to operate--- BUT, WAIT. Is the antenna suitable? Usually, 2:1 is suitable but, the GALAXY V is designed for antennas which present a resistive load of 40-100 Ohms. Only small reactance can be tolerated. Such an antenna should be provided.

SECTION II

2-4 ANTENNA CONSIDERATIONS, continued.

There are many considerations to a proper antenna system, which are too broad in scope to be covered here. The user should refer to appropriate handbooks.

SECTION III

3-1 TRANSMITTER TUNE-UP

After some time of use, the operator can quickly tune most any equipment, however, we believe this unit will prove easy to tune the first time, if the operator will read the instructions carefully, before trying to tune the equipment.

TO RECEIVE ONLY, just adjust the EXCITER tuning control for best reception.

To set-up for transmitting, set the sideband selector switch to SB-2. (It must be on SB-2 whenever the function switch is, or will be, set to either TUNE or CW positions). Set the MIC. GAIN fully clockwise. Set the LOAD control fully counter-clockwise. -----The next step places the equipment in a transmit condition, so proceed promptly to complete the following steps-----Set the function switch to TUNE position--adjust the EXCITER control for maximum meter reading--adjust the PLATE control for a "dip" in plate current (minimum meter reading). Now, to load to rated power, advance the LOAD control clockwise to produce a slight increase in meter reading, then re-adjust the PLATE control for a "dip". Repeat advancing the LOAD control clockwise and then re-adjusting the PLATE control until the last adjustment of the PLATE control produces a "dip" where the meter reading is at the word "tune" above the small triangle marking on the meter. --- Now turn the MIC. GAIN control down, counter-clockwise, until the meter reading drops to the S7 marking on the meter and then re-adjust the EXCITER control, as necessary, to produce maximum or peak meter reading. Now set the MIC. GAIN fully counter-clockwise. Tuning is now complete and the function switch may be returned to PTT or VOX positions as desired for the method of keying to be used. Set the sideband selector to upper or lower (U-upper/L-lower on the indicator lamps on the right hand side of the panel) sideband as desired.

Now, for voice operation, you may energize the transmitter section with PTT or VOX as desired and while speaking into the microphone in a normal voice, advance the MIC. GAIN control clockwise until the meter swings up to the word "tune" at the triangle marking on the meter. This represents full 300 watts P. E. P. input power. The physical setting of the gain control is of no importance and the proper setting is where voice output from the microphone causes the meter to swing to the proper meter reading.

SECTION III

3-1 TRANSMITTER TUNE-UP, Continued

If you desire to operate CW you do NOT tune differently than above. For CW use plug in a suitable key, set the MIC. gain full clockwise, set the SIDEBAND selector to SB2. Now when you place the FUNCTION switch to CW you will be in transmit condition and will transmit a signal whenever you close the key. To return to receive condition, you must manually return the FUNCTION switch to PTT position. You should unplug the microphone from the set when operating CW. As shifted carrier CW is used, you will be approximately on the received signals frequency when you have the received signal tuned in so as to produce about a 1,000 cycle tone in the speaker. Also, if you should want to operate with reduced power for a local CW QSO, you may directly control power input by the MIC. gain control. When the MIC. control is full clockwise you will run full power (the meter will read higher than SB and indicate about at the CW power mark) and, if you want less power, simply reduce the MIC. gain control setting. This will show less power by a lower meter reading. NO TUNING IS TO BE DONE WITH THE FUNCTION SWITCH IN THE CW POSITION.

Don't forget to close the key or unplug it when returning to voice operation, or the transmitter will not work.

NOTE: If in the tuning above, the first dip, with the LOAD control at minimum, results in a dip above the TUNE mark on the meter, it indicates the antenna impedance is below that for which the PI-net can match. If full rotation of the LOAD control will not bring the current up to the TUNE mark, it indicates the impedance of the antenna is above that which the PI-network can match. In either case, the only solution is to adjust the antenna to present a load within the capabilities of the PI-network.

3-2 MOBILE OPERATION

In most all respects, operation in mobile use is the same as fixed station. Tuning is the same, however, the final bias control R-33 must be re-set (see set-up adjustments) when a different supply is used, as when changing from house to car.

SECTION III

3-2 MOBILE OPERATION, Continued

We believe the following pictures typify installation of our mobile bracket. It is a very universal bracket and one which permits easy removal of the GALAXY from the car. Additional details are provided with the mount.

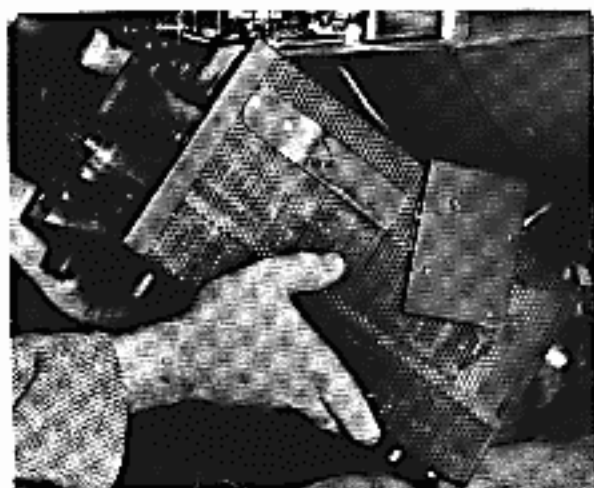
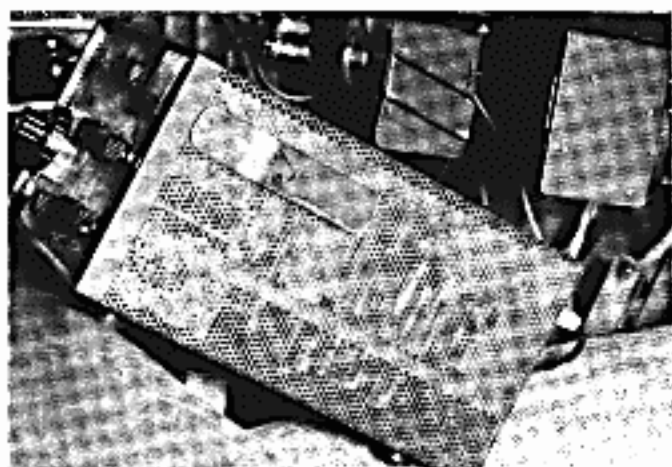

The mobile mounting ears that attach to the side of the GALAXY cabinet **MUST** be removed to remove the transceiver from its cabinet. The **SHORT** sheet metal screws provided must be used to prevent damage to components inside the GALAXY.

The transistors used are well heat protected, however, on a hot sunny day and all the car windows closed for a long time, great heat can build up in the car. This is indicated by the fact that many metal parts of the car cannot be touched for some time after opening up the car. In such case, allow a few minutes to ventilate the car and let metal parts cool down. This will help protect the transistors in the audio section. Operating the car vent fan a minute or two should cool the unit sufficiently. If you can touch the back panel and it is not too hot to hold, there should be no problem.

The DC supply should be mounted as near the battery as possible, but in no case where the primary leads will be over 4 feet in length. The DC supply should be positioned high on the fender well out of direct water

SECTION III

3-2 MOBILE OPERATION, continued

splash as much as possible. It is best to position the DC supply used so the plug or cable carrying high voltage is to the rear, towards the firewall, to minimize water causing an arc. Most DC supplies will NOT receive adequate ventilation if mounted inside the car. The engine compartment is hot, but air movement will normally result in better cooling in the engine compartment. It is best to mount the DC supply forward as much as possible, so the motor fan will cool it. Refer to the instructions with your DC supply for specific requirements applicable.

The cable carrying high voltage, bias, filaments, etc. , should be no longer than 10' unless the wires carrying filament voltage are larger than #18 wire, which is the minimum size wire that should be used on filament leads. The other wires may be as small as #22, but also keep in mind the wires carrying high voltage and bias should have adequate insulation.

The plug for main power and control circuits on the rear of the GALAXY has the following connections:

- #1--800VDC, pos.
- #3--325VDC, pos.
- #5--12VDC
- #6--12V AC/DC
- #7--ground
- #9--100VDC neg.
- #11 -- off-on switch
- #12 -- off-on switch

Picture below shows regular mobile bracket mounted on top of accessory ZMM floor mount bracket for increased height and high angle of tilt often desired with floor mounting. The ZMM bracket must be used with the regular mobile mount. The ZMM is available at \$3.00.

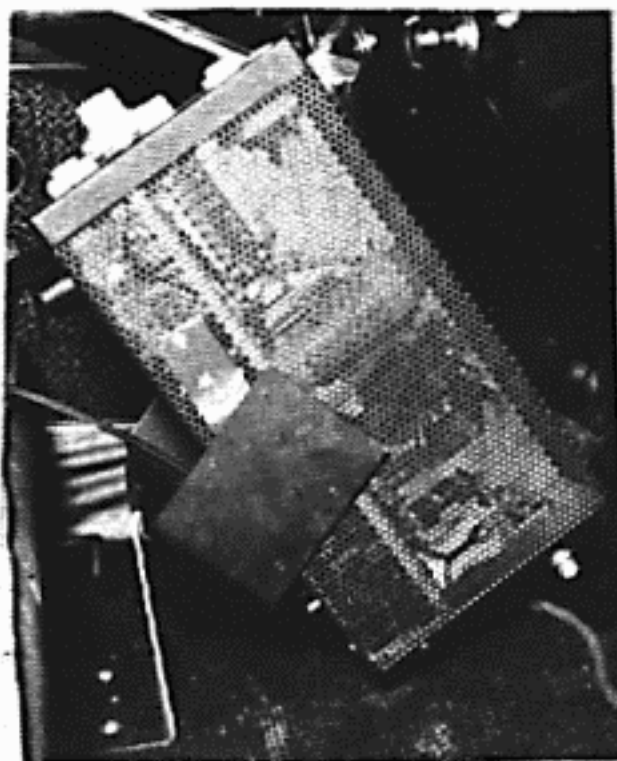

SECTION III

3-3 CONNECTION AND USE OF ACCESSORY ITEMS

The jacks and plugs for connections of accessory items is shown in the drawings in section 2-2. The various accessories and their use will be covered in each manual for the various accessories in detail.

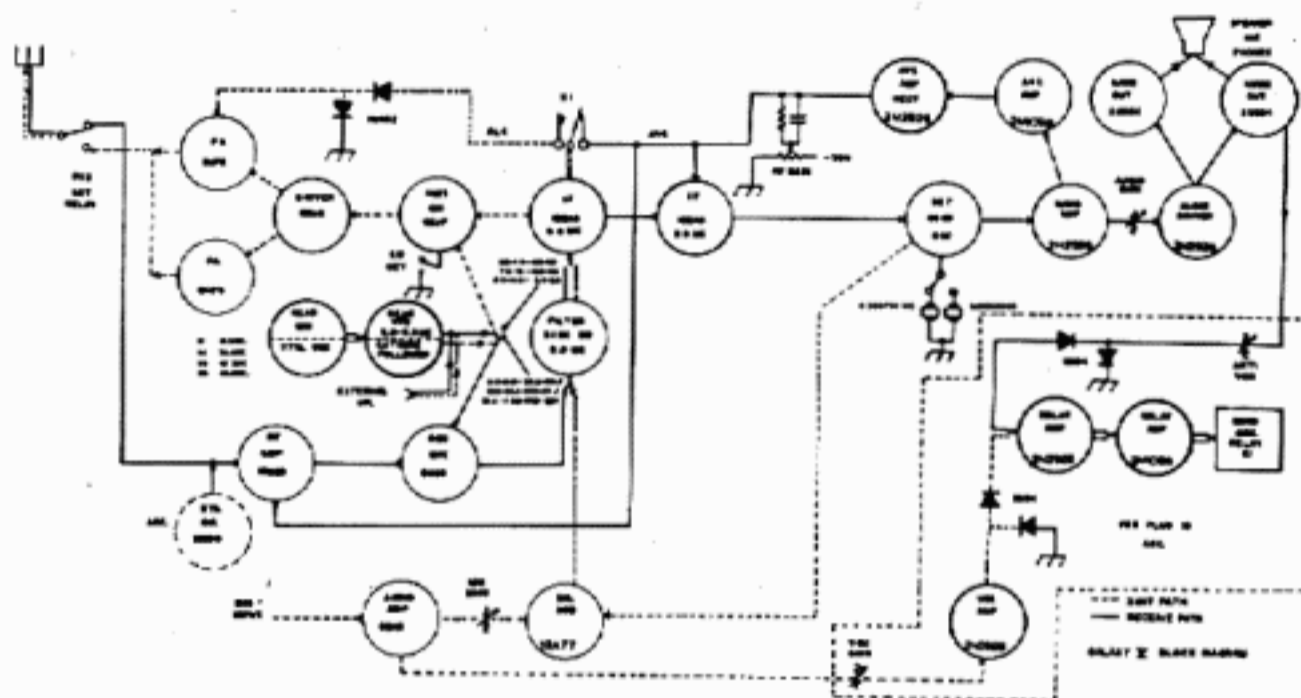

SECTION IV

THEORY OF OPERATION

4-1 GENERAL CIRCUIT ANALYSIS

TRANSMIT OPERATION

The voice signal from the microphone is fed to the mike input jack. The voice signal is amplified in the 6EA8 triode pentode tube and coupled to the 12AT7 dual triode balanced modulator. Also being fed into the balanced modulator is 9,001,250 Kc. or 8,998,750 Kc. which was generated in the 6GX6 oscillator-detector tube. The 12AT7 balanced modulator combines the audio and the RF to put out a double sideband

SECTION IV

4-1 GENERAL CIRCUIT ANALYSIS, Continued

suppressed carrier signal at 9,001,250 Kc. for lower sideband or 8,998,750 Kc. for upper sideband. The double sideband signal passes through the 9.0 Mc. filter which allows only one sideband to reach the 12BA6 IF amplifier. The single sideband suppressed carrier signal is amplified in the 12BA6 tube and coupled to the 6EJ7 transmit mixer. A signal at 5.0 to 5.5 Mc. from the VFO for the 80-20 meter operation, or from the 6EA8 converter tube at 16.0 to 16.5 Mc. for 40 meter operation, or 30.0 to 30.5 for 15 meter operation, or 37.0 to 38.0 Mc. for 10 meter operation, is also fed into the 6EJ7 transmit mixer. The sum or difference frequency, whichever is the desired output frequency, is selected by the tuned circuits and fed to the 6GK6 driver stage. The 6GK6 drives the final amplifier, a pair of 6HF5's. The IN462 ALC rectifiers detect any trace of grid current in the 6HF5's, and develops a bias voltage which is applied to the 12BA6 to reduce the IF gain whenever grid current flows, thus keeping the final linear in class AB-1, and reducing distortion while increasing effective talk power. The plates of the 6HF5's are connected in parallel to the PI-network output circuit. In CW operation the crystal oscillator is shifted to 9.0 Mc. to provide carrier, and the 6EJ7 is grid block keyed.

RECEIVE OPERATION

The incoming signal from the antenna is coupled to the 12BZ6 receive RF stage through the antenna relay. The output of the 12BZ6 is fed to the 6HG8 receive mixer. A signal at 5.0 to 5.5 Mc. from the VFO is also fed to the 6HG8 for 80-20 meter operation, or from the 6EA8 converter tube at 16.0 to 16.5 Mc. for 40 meters, or 30.0 to 30.5 Mc. for 15 meter operation, or 37.0 to 38.0 Mc. for 10 meter operation. The output of the 6HG8 receive mixer is fed through the 9.0 Mc. crystal filter to the 12BA6 IF amplifier. The signal is further amplified by a second 12BA6 IF amplifier, then fed to the 6GX6 product detector-oscillator tube. The result is an audio signal that is amplified by the 2N2926 transistor. The output of the 2N2926 feeds both the 2N1098 AVC amplifier and the 2N2926 audio driver stage. The driver feeds the push-pull 2N554 audio output stages, which is coupled to the loudspeaker. The output of the 2N1098 AVC amplifier is rectified by the 2N2926 AVC rectifier and the resulting DC voltage is fed to the receiver first RF, the first and second IF amplifiers, and controls the gain of these tubes.

THE VOX CIRCUITRY

The VOX unit is an optional plug-in unit, as shown in the dotted lines in the block diagram. A portion of the audio output from the 6EA8 microphone amplifier tube is fed to the VOX amplifier 2N2926 transistor. The output of the 2N2926 transistor is rectified by the IN54 diodes and the resulting positive voltage is fed to the two stage DC amplifier which operates the transmit-receive relay K1. The two stage DC amplifier is comprised of a 2N2926 and a 2N1098 transistor.

SECTION IV

4-1 GENERAL CIRCUIT ANALYSIS, Continued

A portion of the receive audio output from the 2N554 output stage is rectified by the 1N54 diodes and the resulting negative DC voltage is also coupled to the two stage DC amplifier. This negative DC voltage balances out any positive DC voltage that may be coming from the VOX amplifier diodes due to the output from the loudspeaker feeding back into the microphone.

4-2 PERFORMANCE SPECIFICATIONS

(A) GENERAL

Frequency coverage of the GALAXY V as factory supplied is as follows: 3.5/4.0, 7.0/7.5, 14.0/14.5, 21.0/21.5, 28.0/29* Mcs. (* The 10 meter band is covered in two 500 Kcs. ranges, factory supplied 28.0/28.5 and 28.5/29.0 Mcs. It is possible, by the installation of optional crystals, to cover other segments of 28.0/30.0 Mcs.)

Linear capacity tuned VFO; tunes 5.0/5.5 Mcs. at all times. 9.0 Mc. crystal plus VFO frequency covers 20 meters, 9.0 Mc. crystal minus VFO frequency covers 75-80 meters, VFO plus crystal osc. mixed in pre-mixer and 9.0 Mcs. crystal covers the 40-15-10 meter bands.

36:1 planetary drive with 2:1 gear drive (spring loaded for anti-backlash) gives 72:1 slow tuning with fast tuning outer knob provided. Circular dial has over 9 inches of bandspread. 5 Kc. dial marks can be interpolated to nearly 1 Kc.

Stability of the VFO is extremely good with drift of less than 100 cps. in any 15 minute period after warmup. Less than 100 cps. frequency change for 10% change of line voltage.

(B) TRANSMITTING SPECIFICATIONS

300 watts CW, carrier shifted 1000 cps. into bandpass. Grid block mixer keying.

300 watts PEP, SSB input power.

Upper or lower sideband, panel selected.

PTT (or VOX with accessory)

Sideband suppression in excess of 55 DB

Carrier suppression in excess of 45 DB

Overall audio response down 6 DB at 300 and 2,400 cps.

Output impedance, nominal 50 Ohms (40-100 Ohms resistive), adjustable PI-net

SECTION IV

4-2 PERFORMANCE SPECIFICATIONS, Continued

A. L. C. used to obtain maximum power and minimize flattopping, as well as increasing talk-power.
High impedance microphone input.

(C) RECEIVING SPECIFICATIONS

Less than 1/2 microvolt produces better than 10 DB S/N.
Full AGC. Audio varies less than 6 DB for 60 DB change. Two speed AGC provides fast attack-fast release for signal variation of 20 DB and slow attack-slow release for greater signal variation. Essentially free from pops and pumping over 40 DB range and free over any range with proper use of RF gain control.
Antenna input impedance: nominal 50 Ohms.
Speaker output impedance: 4 to 8 Ohms, nominal.
Audio power output 3 watts at low distortion.

(D) POWER REQUIRED

800 VDC @400 Ma. with 10% regulation for 80 to 400 Ma. swing.
350 VDC @200 Ma. with 10% regulation.
Negative 100 VDC @35 Ma.
12.6 VAC/DC @5 Amp.
12.6 VDC @1 Amp.

SECTION V
5-1(a)

VOLTAGE CHART

Pin	1	2	3	4	5	6	7	8	9	10	11	12
V1	$\frac{-.67}{0}$	$\frac{.62}{4.8}$	0	13.0 AC	$\frac{295}{285}$	$\frac{125}{-45}$	0					
V2	$\frac{.84}{4.7}$	$\frac{-.1}{-105}$	$\frac{.84}{4.7}$	6.8VAC	0	$\frac{-.38}{0}$	$\frac{31}{-40}$	$\frac{295}{-45}$	$\frac{31}{-40}$			
V3	-.67	0	13.0V AC	0	$\frac{280}{270}$	$\frac{115}{105}$	$\frac{.62}{.60}$					
V4	$\frac{-.66}{0}$	0	13.0V AC	0	285	$\frac{120}{-47}$	$\frac{1.5}{4.7}$					
V5	$\frac{-3}{-2.5}$	3.2	6.8V AC	0	135	$\frac{152}{142}$	0					
V6	$\frac{280}{270}$	-.85	22.5	13.0V AC	6.8V AC	$\frac{70}{68}$	$\frac{.78}{.76}$	$\frac{61}{58}$	$\frac{55}{53}$			
V7	$\frac{150}{140}$	0	$\frac{60}{1.8}$	0	13.0V AC	$\frac{150}{140}$	0	$\frac{60}{1.8}$	6.8V AC			
V8	$\frac{66}{2.5}$	0	$\frac{66}{2.5}$	0	6.8V AC	0	$\frac{295}{280}$	$\frac{290}{175}$	0			
V9	$\frac{66}{3.5}$	0	0	6.8V AC	13.0V AC	NC	$\frac{400}{380}$	$\frac{400}{160}$	0			
V10	6.6V AC	NC	$\frac{0}{150}$	$\frac{0}{.01}$	-70	$\frac{0}{150}$	NC	$\frac{0}{150}$	-70	$\frac{0}{.01}$	$\frac{0}{150}$	13.0V AC
V11	6.6V AC	NC	$\frac{0}{150}$	$\frac{0}{.01}$	-70	$\frac{0}{150}$	NC	$\frac{0}{150}$	-70	$\frac{0}{.01}$	$\frac{0}{150}$	0
V12	NC	NC	NC	NC	150	NC	0					
V13	NC	NC	NC	NC	$\frac{0}{150}$	NC	0					
V14	$\frac{185}{175}$	-3	105	0	6.8V AC	140	.22	$\frac{6.2}{5.9}$	0			
V15	125	$\frac{-.44}{-.56}$	$\frac{145}{135}$	0	13.0V AC	$\frac{205}{195}$	$\frac{3.8}{3.7}$	$\frac{3.8}{3.7}$	$\frac{0}{-.2}$			

SECTION V
5-1(A)

TRAN.	EMITTER	BASE	COLLECTOR
Q1	$\frac{4.1}{4.5}$	$\frac{4.8}{4.9}$	$\frac{9.9}{10.1}$
Q2	$\frac{9.2}{10.0}$	$\frac{9.2}{10.0}$	$\frac{6.0}{5.9}$
Q3	$\frac{3.1}{13.0}$	$\frac{4.5}{4.8}$	$\frac{10.0}{13.0}$
Q4	$\frac{13.0}{14.0}$	$\frac{12.5}{14.0}$	$\frac{.17}{14.0}$
Q5	$\frac{13.0}{14.0}$	$\frac{12.5}{14.0}$	$\frac{.17}{14.0}$
Q6	— 22.0	— 22.0	$\frac{-.6}{0}$

NOTE: All measurements are made from ground to the point being measured. AC power supply connected to the Galaxy and neither VOX or calibrator installed. Bandswitch set on 40 meters (7.0 to 7.5 Mc.), function switch set on PTT, RF gain control full clockwise, AF and Mic. gain set full counter clockwise. Plate, load or exciter controls may be set anywhere.....

Where two voltages are shown, the top is that obtained in receive mode and the bottom one in transmit mode.....

NOTE: Measurements accurate ONLY when made with a Hewlett-Packard 410B VTVM. DO NOT USE A VOM!

Pin	1.	2.	3.	4.	5.	6.	7.	8.	9.	10.	11.	12.
V1	3.3M	47	0	.4	45K	43K	0					
V2	150	100K	.50	.4	0	100K	100K	47K	100K			
V3	3.3M (RXIM)	0	.4	0	48K	100K	47					
V4	3.3M (RXIM)	0	.4	0	48K	42K	100					
V5	2.2M	1K	.4	0	250K	100K	22K					
V6	47K	1M	1.1M	.4	.45	280K	680	1K	125K			
V7	51K	100K	**	0	.4	51K	0	**	.35			
V8	**	100K	**	0	.4	0	47K	88K	0			
V9	**	22K	0	.35	.4	**	47K	75K	0			
V10	.2	**	27K	2.5	7.6K	27K	**	27K	7.6K	2.5	27K	.2
V11	.2	**	27K	2.5	7.6K	27K	**	27K	7.6K	2.5	27K	0
V12	NC	NC	NC	NC	47K	NC	0					
V13	NC	NC	NC	NC	27K	NC	0					
V14	50K	47K	80K	0	1.5	52K	30	470	100			
V15	50K	10K	75K	1.5	.4	50K	220	220	100K			
Transistor	Emitter		Base		Collector							---
Q1	420		3.2K		330							---
Q2	420		650		2.3K							---
Q3	820		5K		400							---
Q4	2.2		2.8		.8							---
Q5	2.2		2.8		.8							(** open circuit)
Q6	13K		21K		3.1M(RXIM)							---

Power

Plug

P1

	1.	2.	3.	4.	5.	6.	7.	8.	9.	10.	11.	12.
	**	NC	47K	NC	4.5	.4	0	NC	6.5K	***	**	**

(***) tie point for R 114)

NOTE: All measurements are made from ground to point being measured. Power Supply disconnected from GALAXY. VOX and XTAL cal. are not plugged in. All tubes, relay and jumper plugs in their sockets. The band switch set on 14.0-14.5, the function switch set on cal. AF, RF gain and Mic. Gain set fully clockwise. Side-band switch set on SB2. All measurements to be made with a Hewlett Packard 410B VTVM only.

SECTION V

5-2 ALIGNMENT

This is a complicated apparatus, and alignment should not be attempted without a full understanding of the circuitry and adequate equipment.

DANGER: HIGH VOLTAGE! USE EXTREME CAUTION WHEN THE UNIT IS OUT OF THE CABINET, AS VOLTAGES DANGEROUS TO LIFE EXIST!

TEST EQUIPMENT REQUIRED:

Calibrated signal generator
100 KC crystal calibrator
50 Ohm dummy load capable of handling 200 watts
Output indicator - oscilloscope - RF Analyzer - RF volt meter
Audio signal generator
VTVM or VOM

IF AMPLIFIER ALIGNMENT

1. Remove VOX unit or VOX jumper board from J9. This will prevent you from accidentally keying the transmitter into the signal generator.
2. Set controls as follows:
 - a. RF full clockwise
 - b. Function switch - PTT
 - c. Load Control - 10 o'clock
 - d. Plate Control - 12 o'clock
 - e. Band Switch - 7.0 to 7.50 mc.
3. Connect signal generator output to GALAXY antenna jack.
4. Set volume control at half scale and allow five minutes for unit to warm up.
5. Adjust potentiometer R-2 for zero S-meter reading.
6. Set signal generator at 10,000 mv. output, 9.000 mc. Vary generator frequency until beat note is heard in transceiver loudspeaker. Adjust plate control for maximum S-meter reading. Set signal generator output level for approximately S-6 on GALAXY S-meter.
7. Adjust the slug of L-9 and the top and bottom slug in T-4 for maximum S-meter reading. Reduce the signal generator level to keep S-meter reading below S-6.
8. Adjust slug in L-1 (9.0 mc. trap to eliminate IF leak-thru) for minimum S-meter reading.

VFO ALIGNMENT

1. Set controls as follows:
 - a. RF full clockwise

SECTION V

5-2 ALIGNMENT, Continued

- b. **FUNCTION** switch to **CAL**, (if there is no plug-in crystal calibrator in the unit, any other accurate frequency source at 3.5 and 4.0 Mc. may be used.
 - c. **BANDSWITCH** to 80 meters (3.5 to 4.0 Mc.)
 - d. **EXCITER** control to approximately 10 o'clock position.
 - e. **SIDEBAND** switch to SB1 position.
 - f. **CAL, ADJ.** control to midrange.
 - g. **MAINTUNING DIAL** to be set at 4.0 Mc.
2. Adjust maintuning dial until calibrate signal at 4.0 Mc. is heard. (check to be sure this is the 4.0 Mc. signal with a signal generator, if possible.)
 3. Adjust L-18 and main tuning dial until calibrator zero beat signal occurs at 4.0 Mc.
 4. Set main tuning dial to 3.5 Mc. Rock tuning dial until calibrator signal is heard.
 5. Adjust C-5 and main tuning dial until calibrator zero beat signal occurs at 3.5 Mc.
 6. Repeat steps 2 through 5 until calibrator zero beat occurs at 3.5 and 4.0 Mc. dial markings.

CONVERTER ALIGNMENT

CONVERTER ALIGNMENT WILL BE DONE IN RECEIVING

Make a test load circuit as illustrated below.

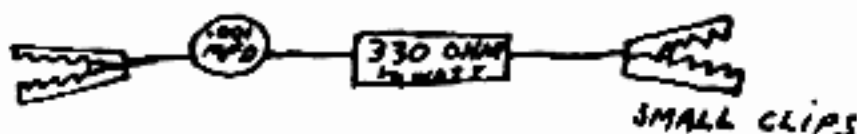
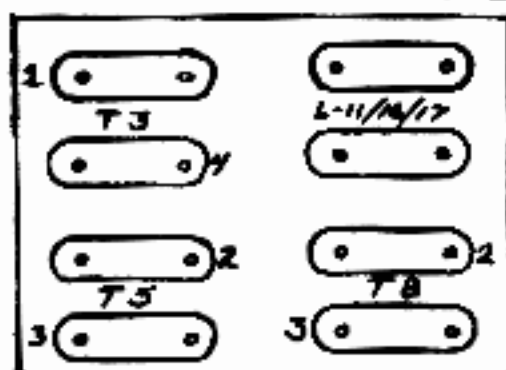

Illustration to left is lug or terminal side of converter sub-chassis.

- For the following steps, do each alignment using the directions in the first bracket(), then repeat all steps with second() bracket figures, then the third().
1. Set the bandswitch to (7.0-7.5 Mc.)(21.0-21.5 Mc.)(28.0-28.5 Mc.)
 2. Set the signal generator to (7.250 Mc.)(21.250 Mc.)(28.5 Mc.)
 3. Set the main tuning dial to (7.250 Mc.)(21.250 Mc.)(28.5 Mc.)
 4. Adjust the following for maximum "S" meter deflection:
 5. Coil (L-11, top slug)(L-17, middle slug)(L-16, bottom slug)
 6. On the following steps, turn set off while connecting load clips. Danger, high voltage.
 7. On the next step, connect the test load mentioned above from chassis ground to the lug mentioned adjust the slug mentioned for maximum "S" meter reading.
 8. Adjust bottom slug of (T3, load on lug 4)(T5, load on lug 3)(T8, load on lug 3).
 9. Repeat steps 6 and 7 for the following adjustments.
 10. Adjust the top slug of (T3, load on lug 1)(T5, load on lug 2)(T8, load on lug 2)
 11. Repeat steps 6 through 10 again for more exact alignment.

EXCITER ALIGNMENT

1. Attach an RF output indicator between the Galaxy and a suitable dummy load. If a Heath Antenna is used, a VTVM may be connected as an RF indicator. Replace the VOX or VOX-jumper board. Set the controls as follows:

80 METERS

- a. **BANDSWITCH** to 3.5-4.0 Mc. position.
- b. **SIDEBAND** switch to SB-2.
- c. **PLATE** tuning to 2 o'clock position.

SECTION V

5-2 EXCITER ALIGNMENT, continued.

- d. LOAD control to 10 o'clock.
- e. Set MIC. GAIN maximum counter-clockwise.
- f. Set tuning dial to 4.0 Mc.
- g. Set EXCITER tuning control to 9 o'clock.
- h. Set function switch to TUNE.
- i. Advance MIC. GAIN control until "S" meter rises to S-5.
- j. Adjust L-7 and L-2(bottom slugs) for maximum meter reading.
Keep meter reading below S-6 by using MIC. GAIN control.

2. Return function switch to PTT position.

40 METERS

- a. Set bandswitch to 7.0-7.5 Mc.
- b. Set PLATE control to 12 o'clock.
- c. Set LOAD control to 10 o'clock.
- d. Set MIC. GAIN maximum counter-clockwise.
- e. Set tuning dial to 7.5 Mc.
- f. Set EXCITER tuning to 9 o'clock.
- g. Set function switch to TUNE.
- h. Advance MIC. GAIN until "S" meter rises to S-5.
- i. Adjust L-3 and L-6(top slugs) for maximum meter reading.
- j. Keep meter reading below S-6 by using MIC. GAIN control.

3. Return function switch to PTT position.

10 METERS

- a. Set bandswitch to 28.0-28.5 Mc.
- b. Set PLATE control to 10 o'clock.
- c. Set LOAD control to 11 o'clock.
- d. Set MIC. GAIN to maximum counter-clockwise.
- e. Set tuning dial to 28.0 Mc.
- f. Set EXCITER tuning to 3 o'clock.
- g. Set function switch to TUNE.
- h. Advance MIC. GAIN until "S" meter rises to S-5.
- i. Adjust L-13 and L-15(bottom slugs) for maximum meter reading.
- j. Keep meter reading below S-6 by using MIC. GAIN control.

4. Return function switch to PTT position.

15 METERS

- a. Set bandswitch to 21.0-21.5 Mc.
- b. Set PLATE control to 10 o'clock.
- c. Set LOAD control to 11 o'clock.
- d. Set MIC. GAIN to maximum counter-clockwise.
- e. Set tuning dial to 21.0 Mc.
- f. Set EXCITER tuning to 3 o'clock.
- g. Set function switch to TUNE.
- h. Advance MIC. GAIN until "S" meter rises to S-5.
- i. Adjust L-12 and L-14(middle slugs) for maximum meter reading.
- j. Keep meter reading below S-6 by using MIC. GAIN control.

Return function switch to PTT position.

SECTION V

5-2 EXCITER ALIGNMENT, continued.

5.

20 METERS

- a. Set bandswitch to 14.0-14.5 Mc.
- b. Set PLATE control to 11 o'clock.
- c. Set LOAD control to 11 o'clock.
- d. Set MIC. GAIN to maximum counter-clockwise.
- e. Set tuning dial to 14.0 Mc.
- f. Set EXCITER tuning to 3 o'clock.
- g. Set function switch to TUNE.
- h. Advance MIC. GAIN until "S" meter rises to S-5.
- i. Adjust L-5 and L-4 (top slugs) for maximum meter reading.
- j. Keep meter reading below S-6 by using MIC. GAIN control.
Return function switch to PTT position.

CARRIER SUPPRESSION ADJUSTMENT

1. Attach an output indicator and dummy load, as in previous alignment.
2. Set the bandswitch to 7.0-7.5 Mc., and the tuning anywhere in this range.
3. Tune up the transmitter for normal SSB use, then place in PTT position.
4. Set MIC. GAIN fully counter-clockwise and operate microphone PTT.
5. Observe output power indication on indicator used.
6. Adjust sensitivity of output indicator as needed for good indication.
7. Adjust C-7 and R-1 for minimum power output on indicator. These controls interact and may have to be adjusted several times.
8. Set sideband switch to other sideband and observe carrier, if any. If any carrier indicated, C-7 and R-1 may have to be reset at a compromise setting to obtain best suppression for both sidebands.

FILTER TRANSFORMER ALIGNMENT

1. Set bandswitch to 7.0-7.5 Mc., and tuning anywhere in this range.
2. Tune the transmitter for normal SSB operation and place in PTT .
3. Connect an accurately calibrated audio signal generator to the mic. input jack and a switch to the mic. jack to key the PTT circuit. The audio generator is to be set to exactly 1300 cycles and approx. .02 volts.
4. Key transmitter on and advance MIC. GAIN for S-5 meter reading.
5. Tune L-8 for maximum meter reading. Reduce MIC. GAIN as necessary to keep meter reading below S-6.
6. Set the audio generator for a frequency of 2200 cycles.
7. Adjust top and bottom slugs in T-1 for maximum meter reading, keeping meter reading below S-6 with MIC. GAIN control. Open keying switch.

SECTION V

5-2 ALIGNMENT, continued.

1. Adjust the audio generator to a frequency of 800 cycles.
2. Energize transmitter by closing switch on PTT circuit.
3. Adjust MIC. GAIN control for meter reading of S-9.
4. Observe and mark-down the reading on the output indicator used.
5. Reset the audio generator to 300 cycles.
6. Set sideband selector switch to SB-2 and adjust the trimmer C-8 until the output now indicated drops to a value 1/2 the indication obtained previously in step 4.
7. Set the sideband selector switch to SB-1 and adjust trimmer C-9 until the output indicated drops to a value 1/2 the indication obtained previously in step 4. Dis-connect generator and keying switch.
8. REPEAT CARRIER SUPPRESSION ADJUSTMENT section.

P. A. NEUTRALIZATION

1. Set the controls as follows:
 - a. Bandswitch on 28.0-28.5 Mc. position.
 - b. Sideband selector switch to SB-2 position.
 - c. MIC. GAIN to maximum counter-clockwise.
 - d. Set the following, all to 11 o'clock position: EXCITER -PLATE -LOAD
 - e. Set the tuning dial to 28.5 Mc.
 - f. Set the function switch to TUNE and adjust the MIC. GAIN control until the meter reads S-5. Adjust EXCITER tuning for maximum reading.
 - g. Advance the MIC. GAIN control fully clockwise, then adjust the final PLATE and LOAD controls for normal loading to the meter "tune" mark.
 - h. Set the function switch to the CW position.
 - i. Rock the PLATE control slightly through the dip and observe the output indicator. Adjust C13 until the plate current dip and maximum RF output power occur simultaneously. Set function switch to PTT position.

VFO SIDEBAND FREQUENCY SHIFT ADJUSTMENT

1. Set controls as follows:
 - a. Receiving RF gain maximum clockwise.
 - b. Function switch to CAL. (if a calibrator is not in the set use an external signal which is stable, unmodulated, and strong near 3800 Kc.)
 - c. Set the sideband selector to SB-1, the bandswitch to 3.5-4.0 Mc.
 - d. Set the tuning to 3.8 Mc. for the calibrator or other signal used.
 - e. Set EXCITER tuning to 12 o'clock and adjust main tuning for exact zero beat on the reference signal.
 - f. Set the sideband switch to SB-2 and adjust C-4 (on side of VFO assy.) for exact zero beat again.

SECTION VI

6-1 SERVICE INFORMATION

The following information must be included in correspondence if we are to provide the best possible service. Omission may delay service.

SECTION VI

6-1 SERVICE INFORMATION, Continued

- (a) MODEL OF EQUIPMENT IN QUESTION
- (b) EQUIPMENT SERIAL
- (c) DATE OF PURCHASE
- (d) DEALER'S NAME AND ADDRESS
- (e) OUR PART NUMBER OF ANY PART DESCRIBED

INFORMATION ONLY

If only information is desired, address the letter to the attention of the "TECHNICAL DEPARTMENT", stating the exact nature of the problem as briefly as possible, describing parts referred to by our part numbers and listing all measurements taken and effects observed. A brief, concise letter will be helpful.

PARTS ONLY REQUIRED NOT IN WARRANTY

In the event you know exactly what part or parts are required, we prefer that you order them through your dealer, however, whenever possible, we will ship direct where your check, covering parts cost and postage, is included. Where not included, we will ship C. O. D. We do not offer a billing service.

PARTS ONLY REQUIRED IN WARRANTY

Where possible, order parts through your dealer; however, to expedite, we can usually ship from our factory. HOWEVER, for parts to be shipped from our factory on an exchange-in-warranty basis, we MUST have your warranty card on file. It is therefore, IMPORTANT that you mail in your warranty card as soon as possible. On requests for shipment of parts in warranty, where no card is on file, there may be a delay in order to verify warranty with your dealer. Where verification of warranty is in order, we will normally ship replacement parts with a special return label for the defective part or parts.

6-2 RETURNING EQUIPMENT FOR SERVICE

Do NOT ship equipment to us without prior authorization and special return labels. Doing so will usually cause delay.

When shipping equipment, be SURE it is insured with the carrier for compensation against possible shipping damage. We do NOT assume any responsibility for repairs necessary due to shipping damage. Units, received in

SECTION VI

6-2 RETURNING EQUIPMENT FOR SERVICE(continued)

damaged condition will be inspected to ascertain the cost of repairing the damage, and we will advise you of this information. On receipt of the damage information you should immediately file claim with the carrier at the origin of the shipment point. We will be glad to assist you as possible, however, we are unable to assume the responsibility for filing claims for you. Damage is an undesirable situation, but one over which we have no control and consequently we are unable to assume liability for it. It is best avoided by adequate packaging to protect against damage from the rough handling to which shipments are normally subjected. Failure to properly package may well result in the carrier rejecting a claim with the burden of repair costs then falling on the shipper.

It is helpful and will expedite returns if you will mail a separate letter at the time of shipment, or slightly in advance of it, so we will be aware of the shipment prior to receipt. Pack a copy in the shipment and give all details relating to trouble or reason for return. **BE SURE TO STATE ALL REQUIRED INFORMATION, SUCH AS DEALER, PURCHASE DATE, ETC.**

PREPAY ALL SHIPMENTS TO US.

Where equipment is repaired and parts or labor is not covered by warranty, the equipment will be returned with costs collected by the carrier on delivery. We offer no billing service to the consumer of our products.

GALAXY V

Prices subject to
change without notice

Resistor Parts List

<u>R No.</u>	<u>Value</u>	<u>Part No.</u>	<u>Price</u>
1	2.5K Pot	13-7	\$0.60
2	50 K Pot	13-8	1.02
3	6.8 K 1/2 w	10-15	0.12
4	1 K 1/2 w	10-42	0.12
5	100 K 1/2 w	10-32	0.12
6	47 K 1/2 watt	10-13	0.12
7	39 K 2 watt	10-68B	0.24
8	270 ohm 1/2 w	10-68	0.12
9	6.8K 1/2 w	10-15	0.12
10	10 K 1/2 w	10-56	0.12
11	10 K 1/2 w	10-56	0.12
12	22 K 1/2 w	10-6	0.12
13	100 ohm 1 w	10-65A	0.18
14	68 K 1 w	10-68A	0.18
15	100 ohm 1 w	10-65A	0.18
16	10 ohm 1 w 5%	10-71A	0.24
17	10 ohm 1 w 5%	10-71A	0.24
18	10 ohm 1 w 5%	10-71A	0.24
19	10 ohm 1 w 5%	10-71A	0.24
20	100 ohm 1 w	10-65A	0.18
21	33 K 2 watt 5%	10-69B	0.30
22	27 K 1 w	10-49A	0.18
23	1.2 K 1/2 watt 5%	10-78	0.12
24	4.7 K 1 watt	10-35A	0.18
25	22 K 1 watt	10-47A	0.18
26	3.3 meg 1/2 w	10-57	0.12
27	47 K 1/2 watt	10-13	0.12
28	15 K 1/2 w	10-81	0.12
29	47 ohm 1/2 w	10-29	0.12
30	10 K 1/2 watt	10-56	0.12
31	10 K 1/2 w	10-56	0.12
32	6.8K 1/2 w	10-15	0.12
33	7.5 K Pot	13-12	0.60
34	220 ohm 1 w	10-67A	0.18
35	100 K 1/2 w	10-32	0.12
36	100 K 1/2 w	10-32	0.12
37	150 ohm 1/2 w	10-43	0.12
38	47 K 1 watt	10-46A	0.18
39	100 K 1/2 watt	10-32	0.12
40	47 K 1/2 watt	10-13	0.12

Resistor Parts List

<u>R No.</u>	<u>Value</u>	<u>Part No.</u>	<u>Price</u>
41	47 K 2 watt	10-52B	\$0.24
42	47 ohm 1/2 w	10-29	0.12
43	47 K 1/2 watt	10-13	0.12
44	1 K 1/2 w	10-42	0.12
45	1 K 1/2 w	10-42	0.12
46	100 K 1/2 w	10-32	0.12
47	100 ohm 1/2 w	10-7	0.12
48	22 K 1/2 w	10-6	0.12
49	47 K 1/2 watt	10-13	0.12
50	220 K 1/2 watt	10-4	0.12
51	2.2 m 1/2	10-2	0.12
52	1 K 1/2 watt	10-42	0.12
53	3.5 K 10 watt	11-1D	0.36
54	100 K 1/2 watt	10-32	0.12
55	4 K 10 watt	11-12D	0.37
56	470 ohm 1/2 watt	10-53	0.12
57	100 ohm 1/2 watt	10-7	0.12
58	1 K 1/2 watt	10-42	0.12
59	10 K 1/2 watt	10-56	0.12
60	100K 1/2 watt	10-32	0.12
61	1 K 1/2 w	10-42	0.12
62	220 ohm 1/2 w	10-58	0.12
63	part of R76	----	--
64	10 ohm 1/2 w	10-52	0.12
65	100 K 1/2 w	10-32	0.12
66	27 K 1/2 w	10-14	0.12
67	800 ohm 10 watt	11-3D	0.37
68	1 K 1/2 w	10-42	0.12
69	2 ohm 5 watt	11-2C	0.20
70	1 meg 1/2 w	10-10	0.12
71	10 K 1/2 watt	10-56	0.12
72	1 meg 1/2 w	10-10	0.12
73	220 K 1/2 w	10-4	0.12
74	1 K 1/2 w	10-42	0.12
75	1.5 K 1 w	10-21A	0.18
76	10 K (Mic Gain)	13-9	1.25
77	10 K 1/2 w	10-56	0.12
78	120 K 1/2 w	10-76	0.12
79	330 ohm 1/2 w	10-28	0.12
80	100 K 1/2 w	10-32	0.12
81	1.5 K 1/2 w	10-3	0.12
82	1.5 K 1/2 w	10-3	0.12

GALAXY V

Resistor Parts List

<u>R No.</u>	<u>Value</u>	<u>Part No.</u>	<u>Price</u>
83	1 K 1/2 w	10-42	\$ 0.12
84	6.8 K 1/2 w	10-15	0.12
85	6.8 K 1/2 w	10-15	0.12
86	1 K 1/2 w	10-42	0.12
87	18 K 1/2 w	10-80	0.12
88	1 K 1/2 w	10-42	0.12
89	100 ohm 1/2 w	10-7	0.12
90	2.2 K 1/2 w	10-31	0.12
91	10 K (RF gain)	13-18	2.25
92	50 K (AF gain)	(part of R91)	
93	33 K 1/2 w	10-65	0.12
94	4.7 Meg 1/2 w	10-70	0.12
95	330 K 1/2 w	10-69	0.12
96	10 K 1/2 w	10-56	0.12
97	10 K 1/2 w	10-56	0.12
98	270 ohm 1/2 w	10-68	0.12
99	100 ohm 1/2 w	10-7	0.12
100	330 ohm 1/2 w	10-28	0.12
101	10 ohm 1/2 w	10-52	0.12
102	10 Thermistor	210-1	1.35
103	68 K 1/2 w	10-33	0.12
104	33 K 1/2 w	10-65	0.12
105	3.3 M 1/2 w	10-57	0.12
106	100 K 1/2 w	10-32	0.12
107	1 K 1/2 watt	10-42	0.12
108	10 K 1/2 w	10-56	0.12
109	47 K 1/2 w	10-13	0.12
110	6.8 K 1/2 w	10-15	0.12
111	27 K 1/2 w	10-14	0.12
112	4 K 10 w	11-12D	0.37
113	100 K 2 w	10-67B	0.24
114	100 K 1/2 w	10-32	0.12
115	820 ohm 1/2 w	10-75	0.12
116	2.2 K 1/2 w	10-31	0.12
117	10 K 1/2 w	10-56	0.12
118	330K 1/2 w	10-69	0.12
119	680 1/2 w	10-72	0.12
120	220 1/2 w	10-58	0.12

GALAXY V

Capacitor Parts List

<u>C No.</u>	<u>Value</u>	<u>Part No.</u>	<u>Price</u>
1	Factory Selected TCN	20-41	\$ 0.35
2A, B, C	1100 PF variable	25-10	3.15
3	300 PF variable	25-15	8.95
4	5-25 PF NPO	26-6	0.81
5	15 PF variable	25-20	2.67
6	3 PF (Cal. control)	25-19	1.50
7	5-25 PF NPO	26-6	0.81
8	5-25 PF NPO	26-6	0.81
9	5-25 PF NPO	26-6	0.81
10	50 PF (Main VFO tuning)	25-17	1.67
11	140 PF variable	25-21A	2.85
12	140 PF variable	25-21B	2.70
13	4-22 PF Nut. cap. var.	25-11A	1.70
14	150 PF	22-26	0.17
15	680 PF silver mica 5%	22-13	0.40
16	100 PF	22-21	0.16
17	.01 mfd.	20-5	0.24
18	.005 mfd.	20-3	0.15
19	.005 mfd.	20-3	0.15
20	18 PF	22-24	0.12
21	33 PF	22-7	0.12
22	100 PF	20-23	0.15
23	.001 mfd.	20-24	0.15
24	.005 mfd.	20-3	0.15
25	.001 mfd.	20-24	0.15
26	.001 mfd.	20-24	0.15
27	.001 mfd.	20-24	0.15
28	.001 mfd.	20-24	0.15
29	.001 mfd.	20-24	0.15
30	.001 mfd.	20-24	0.15
31	.001 mfd.	20-24	0.15
32	.001 mfd.	20-24	0.15
33	.001 mfd.	20-24	0.15
34	.001 mfd.	20-24	0.15
35	.001 mfd.	20-24	0.15
36	.001 @5 KV	22-18	2.85
37	10 PF	20-27	0.12
38	47 PF	20-50	0.20
39	91 PF (TCZ)	20-30	0.30
40	1000 PF	22-19	0.33
41	2000 PF	22-27	0.40
42	33 PF	22-7	0.12

GALAXY V

Capacitor Parts List

<u>C No.</u>	<u>Value</u>	<u>Part No.</u>	<u>Price</u>
43	10 PF	20-27	0.12
44	.005 mfd.	20-3	0.15
45	18 PF	22-24	0.12
46	33 PF	22-7	0.12
47	100 PF	22-21	0.16
48	.01 mfd.	20-5	0.24
49	.1 mfd. 200V	23-7	0.21
50	.005 mfd.	20-3	0.15
51	.001 mfd.	20-24	0.15
52	.001 mfd.	20-24	0.15
53	.001 mfd.	20-24	0.15
54	33 PF	22-7	0.12
55	.01 mfd.	20-5	0.24
56	.01 mfd.	20-5	0.24
57	50 PF	22-11	0.12
58	.001 mfd.	20-24	0.15
59	.01 mfd.	20-5	0.24
60	.001 mfd.	20-24	0.15
61	7 PF	20-21	0.15
62	50 PF 1000 volt	22-11	0.12
63	470 PF	20-39	0.15
64	.001 mfd.	20-24	0.15
65	25 PF	20-8	0.15
66	.01 mfd.	20-5	0.24
67	500 PF	20-37	0.15
68	.005 mfd.	20-3	0.15
69	25 PF	20-8	0.15
70	.001 mfd.	20-24	0.15
71	7 PF	20-21	0.12
72	.001 mfd.	20-24	0.15
73	.01 mfd.	20-5	0.24
74	500 PF	20-37	0.15
75	.005 mfd.	20-3	0.15
76	.001 mfd.	20-24	0.15
77	100 PF	22-21	0.16
78	.01 mfd.	20-5	0.24
79	120 PF	22-12	0.15
80	39 PF	22-8	0.12
81	.01 mfd.	20-5	0.24
82	2.2 PF		
83	.005 MFD	20-3	0.15

GALAXY V

Capacitor Parts List

<u>C No.</u>	<u>Value</u>	<u>Part No.</u>	<u>Price</u>
84	.005 Mfd	20-3	\$0.15
85	.01 Mfd.	20-5	0.24
86	.001 mfd.	20-24	0.15
87	.001 mfd.	20-24	0.15
88	.01 mfd.	20-5	0.24
89	.05 @ 200v	23-6	0.15
90	.005 mfd.	20-3	0.15
91	.001 Mfd.	20-24	0.15
92	1000 PF (feed thru)	22-28	5.45
93	.001 Mfd.	20-24	0.15
94	.005 Mfd.	20-3	0.15
95	100 PF	22-21	0.16
96	.01 mfd.	20-5	0.24
97	1000 PF	22-19	0.33
98	.01 @ 400v	20-5	0.24
99	.001 mfd.	20-24	0.15
100A, B	40 @ 450v	24-21	2.07
101	.01 mfd.	20-5	0.24
102	.1 @ 50v	20-38	0.45
103	.1 @ 50v	20-38	0.45
104	.01 mfd.	20-5	0.24
105	.01 mfd.	20-5	0.24
106	not assigned		
107	500 PF	20-37	0.15
108	500 PF	20-37	0.15
109	.001 mfd.	20-24	0.15
110	62 PF	22-9	0.15
111	(factory select)		
112	.005 Mfd.	20-3	0.15
113	2 @ 25v	29-4	0.68
114	2 @ 25v	29-4	0.68
115	.1 @ 50v	20-38	0.45
116	.02 @ 50v	20-49	0.24
117	2 @ 25 v	29-4	0.68
118	.22 @ 200v	23-12	0.35
119	.01 mfd.	20-5	0.24
120	2 @ 25v	29-4	0.68
121	.01 mfd.	20-5	0.24
122	100 @ 15v	29-9	0.81
123	.01 mfd.	20-5	0.24
124	120 PF	22-12	0.15
125	.001 mfd.	20-24	0.15

GALAXY V

Capacitor Parts List

<u>C No.</u>	<u>Value</u>	<u>Part No.</u>	<u>Price</u>
126	100 @ 15v	29-9	0.81
127	100 @ 15v	29-9	0.81
128	2000 @ 15v	24-20	2.04
129	.01 Mfd.	20-5	0.24
130	.01 Mfd.	20-5	0.24
131	.005 Mfd.	20-3	0.15
132	.01 Mfd.	20-5	0.24
133	.01 mfd.	20-5	0.24
134	25 PF	20-8	0.15
135	.001 Mfd.	20-24	0.15
136	.01 Mfd.	20-5	0.24
137	.01 Mfd.	20-5	0.24
138	.01 Mfd.	20-5	0.24
139	.005 Mfd.	20-3	0.15
140	4 mfd. 350v	24-18	0.63
141	100 PF	22-21	0.16
142	.005 Mfd.	20-3	0.15
143	.005	20-3	0.15
144	.15 pf	22-38	0.15

GALAXY V

Transformer Choke - Coils

<u>RFC No.</u>	<u>Value</u>	<u>Part No.</u>	<u>Price</u>
1	Plate Choke	30-13	\$ 0.78
2	Choke 15 m VFO	30-14	0.21
3	750 uh RF choke	30-3	0.45
4	750 uh RF choke	30-3	0.45
5	750 uh RF choke	30-3	0.45
6	Choke 10m VFO	30-15	0.24
7	750 uh RF choke	30-3	0.45
8	Choke 40 uh	30-11	0.23
9	2.5 mh	30-9	0.40
10	2.5 mh	30-9	0.40

L No.

1	9.0 Mc. trap coil	42-36	1.20
2	80M PA grid/rec. RF plate coil	part of *	
3	40M PA grid/rec. RF plate coil	42-34 *	1.06
4	20M PA grid/rec. RF plate coil	part of **	
5	20M driver grid/rec. ant. coil	part of ***	
6	40M driver grid/rec. ant. coil	part of ****	
7	80M driver grid/rec. ant. coil	42-31 ****	1.20
8	9.0 Mc. filter coil	42-28	0.90
9	9.0 Mc. I.F. coil	42-27	0.72
10B	Ceramic PA final coil (80-20M)	42-25B	4.35
10A	PA final coil (10-15M wire portion)	40-13	0.76
11	Converter osc. coil, 40M	part of *****	
12	15M driver grid/rec. ant. coil	part of ***	
13	10M driver grid/rec. ant. coil	42-32 ***	1.28
14	15M PA grid/rec. RF plate coil	part of **	
15	10M PA grid/rec. RF plate coil	42-33 **	1.28
16	Converter osc. coil 10M	part of *****	
17	Converter osc. coil 15M	42-35 *****	1.13
18	VFO coil, ceramic, 5.0-5.5 Mc.	42-12	5.25

T No.

1	Balanced modulator transformer	73-7	0.75
2	Transformer 5.0-5.5	76-6	0.96
3	Transformer 40M	76-5	1.10
4	9.0Mc IF can with capacitors	73-6	0.90
5	Transformer 15M	76-3	1.02
6	Driver transformer	74-5	2.10
7	Output transformer	74-6	2.50
8	Transformer 10M	76-4	1.02
9	40M VFO coil	42-37	0.78

GALAXY V

Transformer Choke - Coils

<u>PC No.</u>	<u>Value</u>	<u>Part No.</u>	<u>Price</u>
1	Parasitic plate choke	33-5	\$ 0.41
2	Parasitic plate choke	33-5	0.41

S No.

1B, C, D, E, F, G, H, J, K, L & M	Bandswitch	53-18	5.40
1A	PA coil switch	53-19	1.29
S2	On-off switch	(part of R91-R92)	
3A, B, C, D	Function switch	53-14	1.53
4A, B & C	Sideband select switch	53-13	1.10
1-N & 1-O	Mixer Osc, switch 2 wafer 4 pole	53-20	1.71
1-P & 1-Q	Mixer Osc. switch 2 wafer		

J No.

1	Octal socket 8 pin	61-7	0.25
2	Octal socket 8 pin	61-7	0.25
3	Key jack	102-1	0.45
4	Phone jack conn. & gnd.	100-5	0.15
5	Phone jack conn. & gnd. (1 part)		
6	Phone jack conn. & gnd.		
7	Phone Jack	100-4	0.10
8	3 way PTT mic jack 3/16" ID	103-3	0.65
9	10 conn. VOX socket	61-17	3.50
10	Phono jack single conn & gnd	100-4	0.10
11	Antenna connector	101-1	0.60
12	Phono jack single conn. & gnd.	100-4	0.10

D No.

1	Diode, IN54A	112-IN54A	0.95
2	Diode, IN462	112-IN462	0.72
3	Diode, IN462	112-IN462	0.72
4	Diode, silicon 400 PIV, 500 ma	112-501	0.45

<u>V No.</u>	<u>Tubes</u>	<u>Part No.</u>	<u>Price</u>
1	12BZ6	110-12BZ6	1.13
2	6HG8	110-6HG8	2.18
3	12BA6	110-12BA6	0.83
4	12BA6	110-12BA6	0.83
5	6GX6	110-6GX6	1.25
6	6EA8	110-6EA8	1.60
7	12AT7	110-12AT7	1.53
8	6EJ7	110-6EJ7	1.53
9	6GK6	110-6GK6	1.45
10	6HF5	110-6HF5	3.90
11	6HF5	110-6HF5	3.90
12	OA2	110-OA2	1.32
13	OA2	110-OA2	1.32
14	6EA8	110-6EA8	1.60
15	6EA8	110-6EA8	1.60

Q No.

1	2N2926	111-6	1.40
2	2N1098	111-8	.75
3	2N2926	111-6	1.40
4, 5	2N554's	111-3	(Matched 5.40 pair)
6	2N2926	111-8	.75

Bulbs

NE1	Sideband indicator(lower)		0.57
N2-2	Sideband indicator(upper)		0.57
	VFO Light 6v Min	113-12	0.25

K No.

1	Relay	116-7	8.65
2	Relay	116-8	6.96
M	Meter	115-6	12.10

Filter and Crystals

X No.

X1	21.5 mc crystal	117-6	4.10
X	9 mc crystal filter	117-4	59.00
X2	8,99, .750 Kc crystal	117-4A	9.95
X3	9,001.250 KC crystal	117-4B	9.95
X4	35.5 mc crystal	117-7	4.50
X5	42.5 mc crystal	117-8	4.50
X6	43.0 mc crystal	117-9	4.50

GALAXY V

Miscellaneous Parts

Octal remote socket jumper plug	109-1	0.20
Mica washer for transistor	124-37	0.24
Feet, small	133-15	0.05
Feet, large	133-7/15	0.05
Cabinet	140-13	12.60
Panel front Galaxy V	141-17	4.37

Knobs

VFO Dial Escucheon	130-14-1	0.35
Large VFO tuning knob	130-14-2	0.35
Small VFO tuning knob	130-14-3	0.30
RF gain knob	130-14-4	0.30
On-Off, AF gain knob	130-14-5	0.25
Mic gain knob	130-14-6	0.25
Function switch knob	130-14-6	0.25
Bandswitch knob	130-14-7	0.35
Exciter knob	130-14-6	0.25
Sideband selector knob	130-14-6	0.25
Plate Control knob	130-14-6	0.25
Load control knob	130-14-6	0.25
Cal. adjust knob	151-9	0.25

Hairline (plastic)	172-19	2.35
VFO 2 color dial	172-17	3.30

Manual		2.00
Carton	182-14	1.00
Dummy plug for VOX	200-4	0.45
Brass band switch coupler	172-24	0.20
26 tooth gear	151-2	1.35
52 tooth gear	151-3	1.80
Jackson Drive	172-11A	1.20
Steel 45% Gear	151-10	1.45

Sockets

XV1	61-14S	1.79
XV10, 11	62-5	1.95
XV3, 4, 5, 12, 13	61-12	1.00
XV2, 6, 7, 8, 14, 15	61-13	1.29
XV9	66-15S	2.15
Relay Socket K1	61-16	1.71
VFO Light	67-2	0.20
Vector mtg.	61-18	0.15
Crystal sockets	64-2	0.95

SECTION VIII

8-1 WARRANTY

GALAXY ELECTRONICS warrants each new product manufactured by it to be free from defective material or workmanship and agrees to remedy any such defect or to furnish a new part in exchange for any part of a unit of its manufacture which under normal installation, use and service discloses such defect, provided the unit is delivered by the owner to GALAXY ELECTRONICS or such repair station as may be designated by us WITH ALL TRANSPORTATION CHARGES PAID, and provided that examination, in our judgment, thus discloses it is defective. Component parts, with the exception of tubes, are warranted for 1 year, and tubes and labor for 90 days, from the date of sale to the original purchaser.

This warranty does not extend to any of our products which have been subjected to misuse, neglect, accident, incorrect wiring not our own, improper use or installation. Nor does the warranty cover improper repairs, adjustments, accessories not of our manufacture, or where the serial has been removed, defaced or changed. We do not authorize the purchase of replacement parts by the owner, to replace parts covered by our warranty, nor will we reimburse the owner for such unauthorized purchases.

This warranty applies only to the original purchaser and is not transferable. This warranty is in lieu of all other warranties or specifications expressed or implied and no representative or person is authorized to assume for us any other liability in connection with the sale of our products.

GALAXY ELECTRONICS reserves the right to change circuit design, component specifications, features, or any previously advertised specification at any time without advance notice or incurring any obligation to purchasers of products previously manufactured or sold.

All warranties previously extended are cancelled one year after the last unit of this model has been produced by our factory.

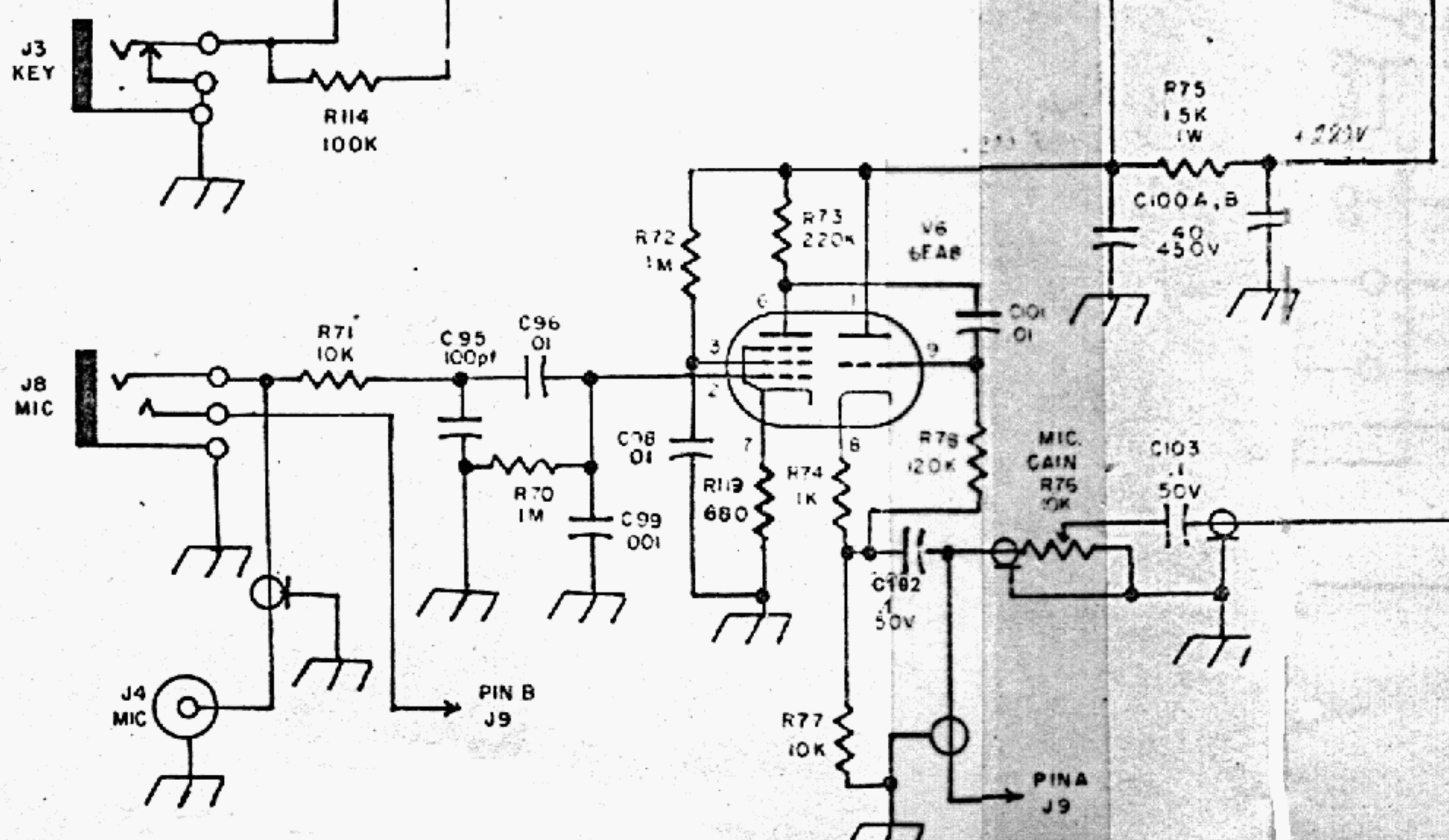
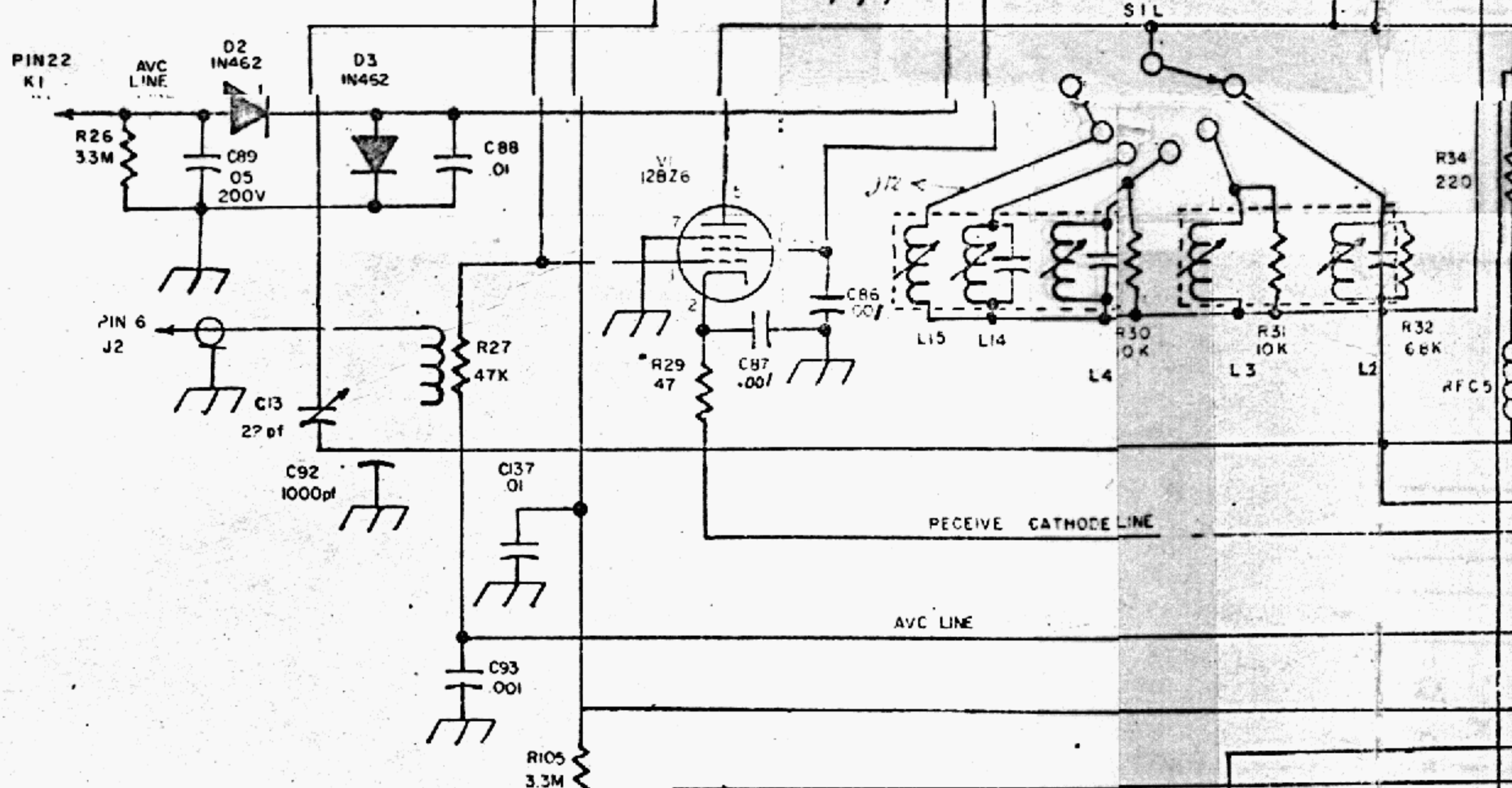
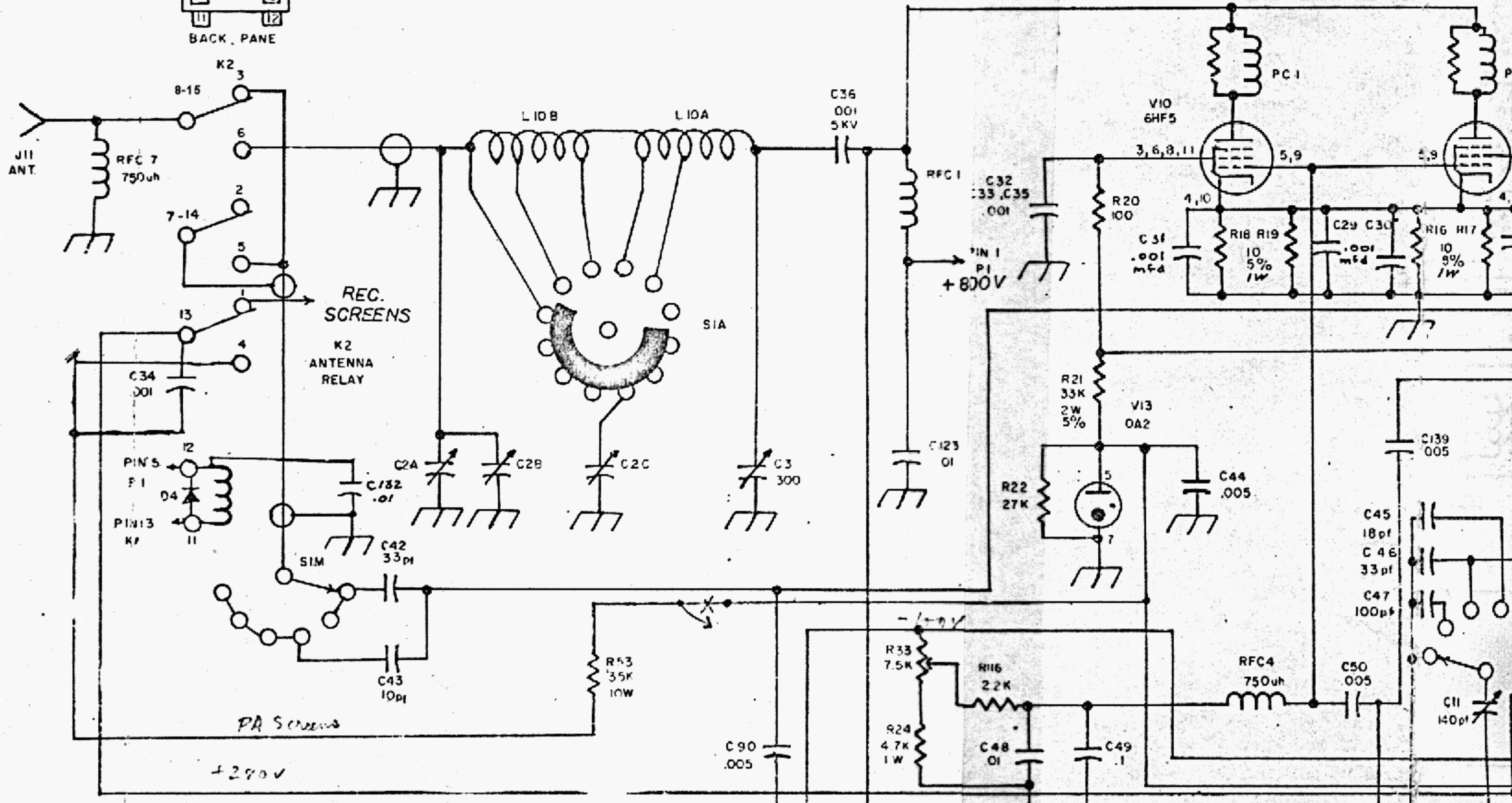
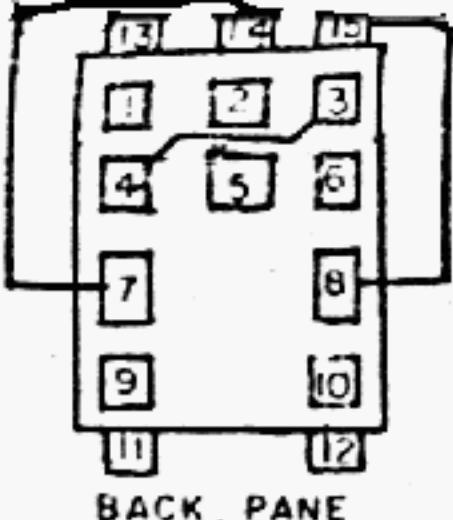

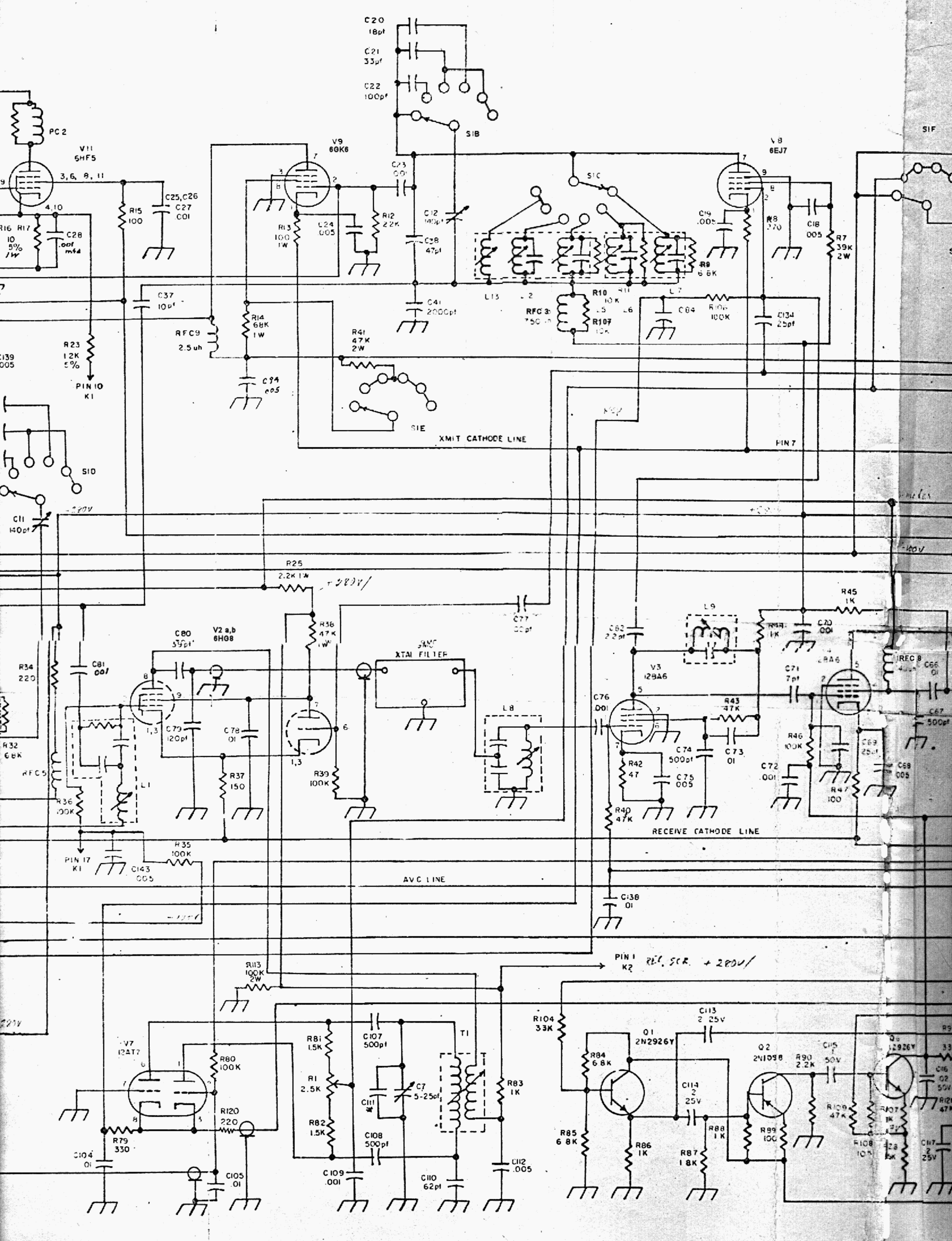

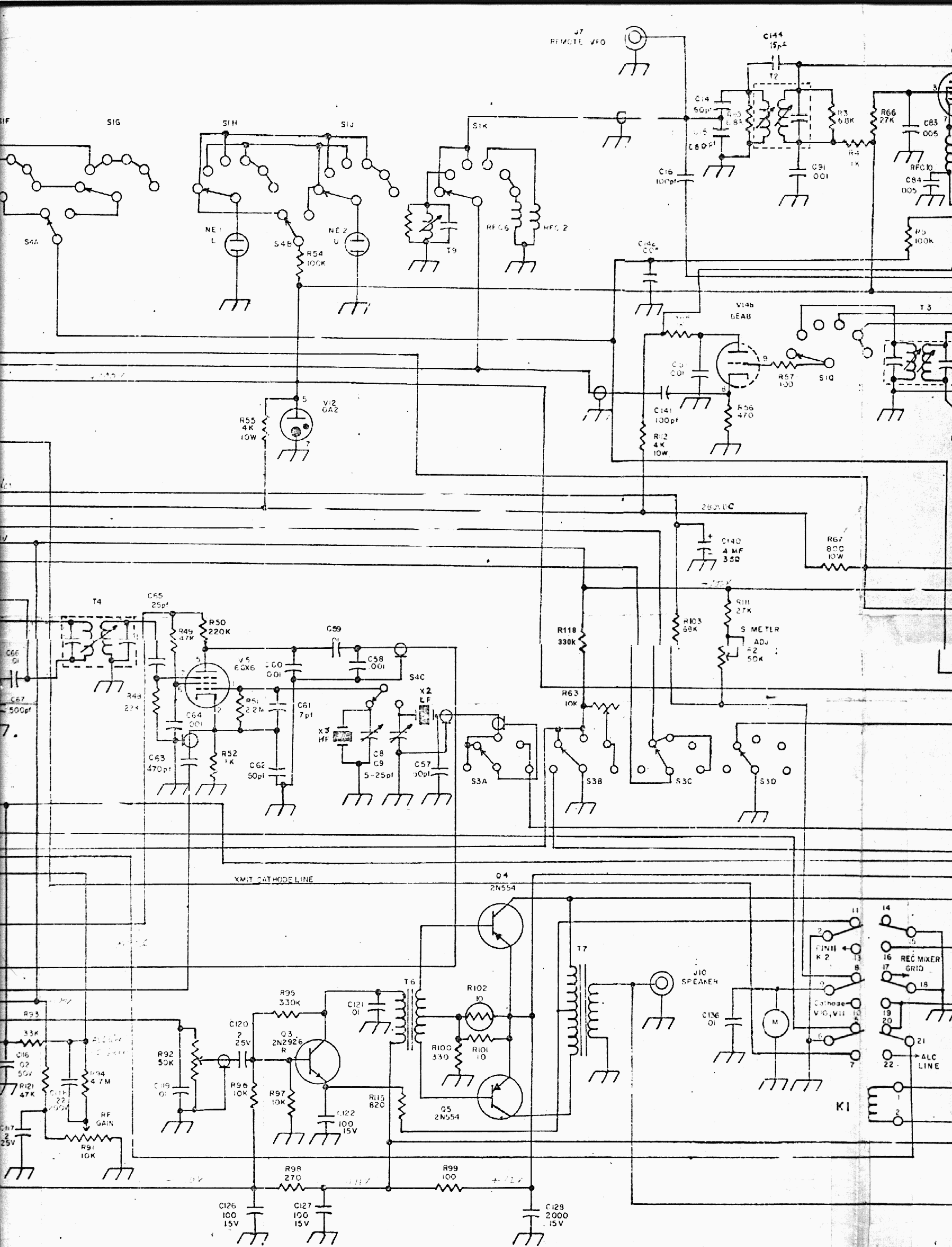

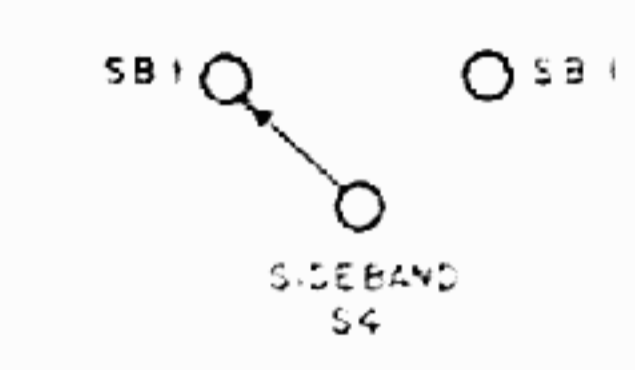
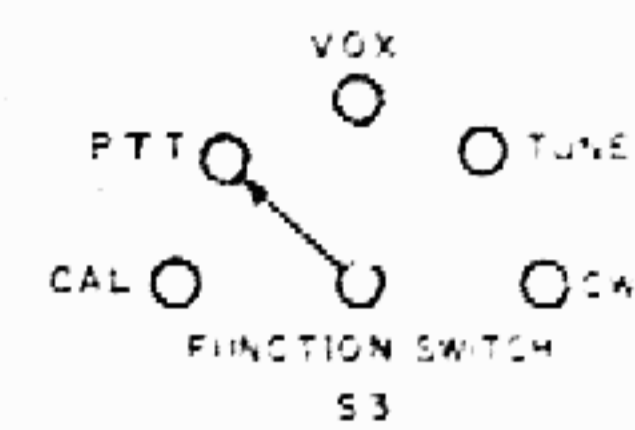
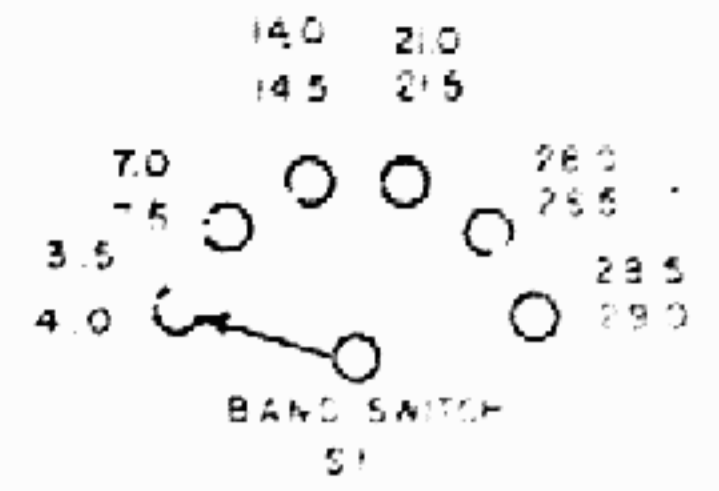
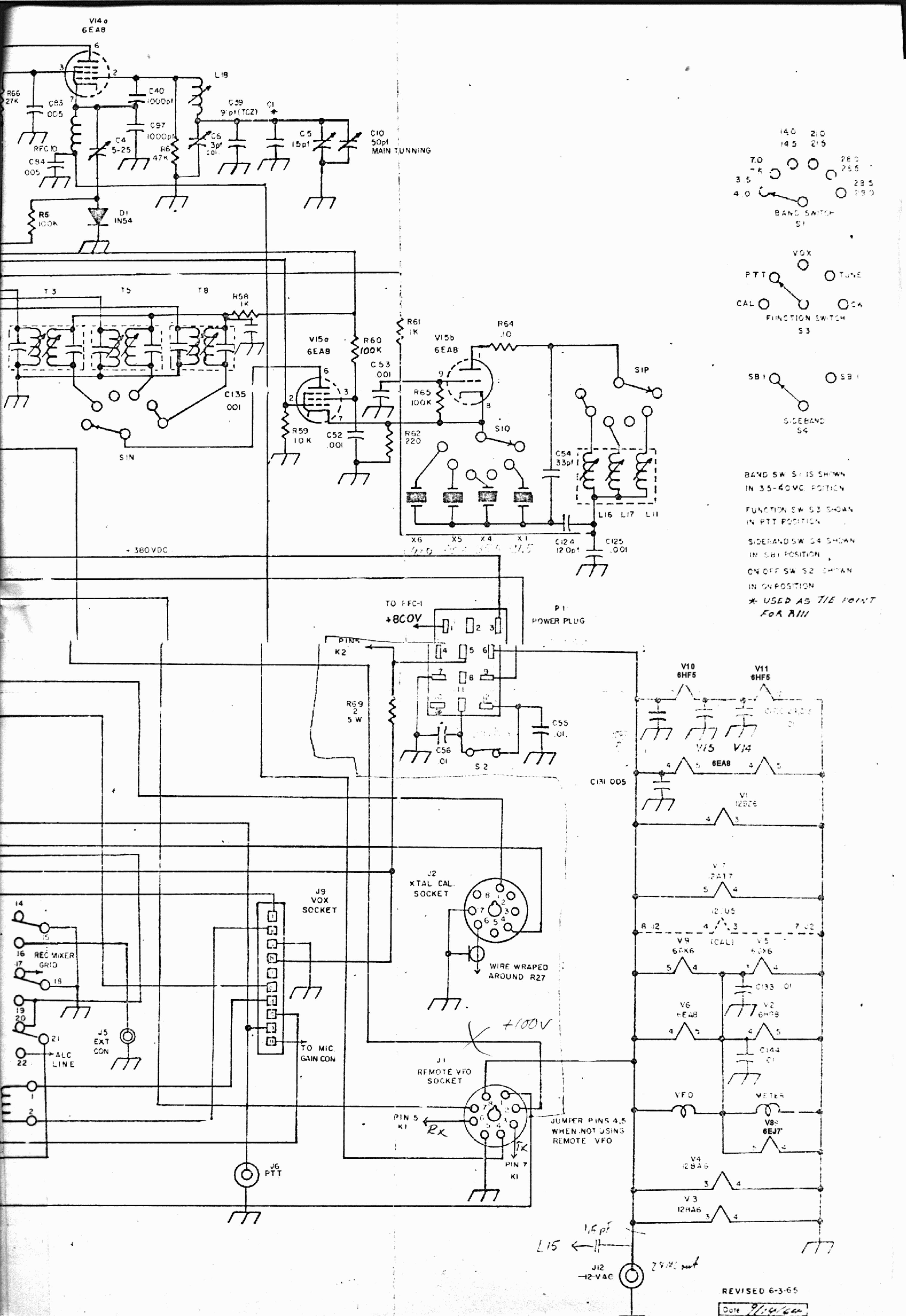

BAND SW S1 IS SHOWN IN 35-40MC POSITION

FUNCTION SW S3 SHOWN IN PTT POSITION

SIDEBAND SW S4 SHOWN IN SB1 POSITION

ON/OFF SW S2 SHOWN IN ON POSITION

* USED AS TIE POINT FOR ALL

REVISED 6-3-65

Date 9/14/66

K4XL's **BAMA**

This manual is provided **FREE OF CHARGE** from the "BoatAnchor Manual Archive" as a service to the Boatanchor community.

It was uploaded by someone who wanted to help you repair and maintain your equipment.

If you paid anyone other than BAMA for this manual, you paid someone who is making a profit from the free labor of others without asking their permission.

You may pass on copies of this manual to anyone who needs it. But do it without charge.

Thousands of files are available without charge from BAMA. Visit us at <http://bama.sbc.edu>